

H-Series

PASSIVE OPTICAL NETWORKING PLATFORM

Technical Description



Content

1	INTRODUCTION	6
1.1	OVERVIEW	6
2	TECHNOLOGY BASICS	8
3	H-SERIES CWDM-FILTERS	10
3.1	OVERVIEW	10
3.2	H-MD-C04L; 4CH LOW CWDM-BAND FILTER	11
3.3	H-MD-C05; 4CH HIGH CWDM-BAND FILTER	12
3.4	H-MD-C08; 8CH LOW CWDM-BAND FILTER	14
3.5	H-MD-C08L-LL; 8CH LOW-LOSS, LOW CWDM-BAND FILTER	15
3.6	H-MD-C09; 8CH HIGH CWDM-BAND FILTER	16
3.7	H-MD-C09H-E-LL; 8CH LOW LOSS, HIGH CWDM-BAND FILTER	17
3.8	H-AD1-Cxx; 1CH CWDM AD-FILTERS	19
3.9	H-AD1-O-1625; 1CH OTDR AD-FILTER	20
4	H-SERIES DWDM-FILTERS	21
4.1	OVERVIEW	21
4.2	H-MD-09-xxxx-yyyy-8C; 800G 8CH DWDM FILTER	22
4.3	H-MD-32-9140-9605; 800G 32CH DWDM FILTER	23
4.4	H-MD-09-xxx-yyy; 8CH DWDM FILTER	24
4.5	H-MD-09-xxx-yyy-em-ll; LOW LOSS 8CH DWDM FILTER	26
4.6	H-MD-09-xxx-yyy-4C; 400G 8CH DWDM FILTER	28
4.7	H-MD-16-xxx-yyy; 16CH DWDM FILTER	29
4.8	H-MD-40-921-960; 40CH DWDM MuxDemux	30
4.9	M-3840-LL; LOW-LOSS 40CH DWDM MuxDemux	31
4.10	H-MD-48-914-961; 48CH DWDM MuxDemux	32
4.11	H-OADM1x4-xxx-yyy; DWDM 1-WAY OADM FILTER	33
4.12	H-OADM2x4-xxx-yyy; DWDM 2-WAY OADM FILTER	34
4.13	H-OADM1x4-xxx-yyy-4C; DWDM 1-WAY OADM FILTER	35
4.14	H-OADM2x4-xxx-yyy-4C; DWDM 2-WAY OADM FILTER	36
4.15	H-OADM1x2-xxx-yyy-4C; DWDM 2CH 1-WAY OADM FILTER	37
4.16	H-OADM2x2-xxx-yyy-4C; DWDM 2-WAY OADM FILTER	38
4.17	H-MD-BP1x5; DWDM BAND SPLIT/COMBINE FILTER	40
4.18	H-MD-BP1x10; DWDM BAND SPLIT/COMBINE FILTER	41
4.19	H-CIRC-3P; DWDM OPTICAL CIRCULATOR	42
4.20	H-MD-04-921-928-SFx & H-MD-04-929-936-SFx	43
5	LANWDM FILTERS	45
5.1	H-MD-4LAN-EM-SFx; LANWDM Mux/DEMUX FILTERS	45
5.2	H-MD-4LAN-295-309	46
6	O-BAND DWDM FILTERS	47
6.1	H-MD-8OWDM-284-289	47
6.2	H-MD-16OWDM-284-314	48

7	SPECIAL APPLICATION FILTERS	49
7.1	H-MD-3155; 1310 / 1550 BAND MUX/DEMUX	49
7.2	H-MD-3155-HI; 1310/1550 Mux/DEMUX, HI ISOLATION	51
7.3	H-SB-XC-6MPO (SHUFFLE BOX WITH 6 MPO-12)	52
7.4	H-BO-1xMPO-10xLC (BREAK-OUT BOX 1xMPO-10xLC)	53
7.5	H-BO-SM-1xMPO-8xLC	54
7.6	H-BO-MM-1xMPO-8xLC	55
7.7	H-D1X4	56
7.8	H-D4X4	57
8	CHASSIS	58
8.1	H-CHASSI-1RU	58
8.2	DCP-PAS-H	59
8.3	H-PPM-CHASSI-1	59
9	TECHNICAL DATA	61
9.1	H-AD1-Cxx	62
9.2	H-AD1-O-1625	64
9.3	H-MD-C04L	65
9.4	H-MD-C05	66
9.5	H-MD-C08	67
9.6	H-MD-C08L-LL	68
9.7	H-MD-C09	69
9.8	H-MD-C09H-E-LL	70
9.9	H-MD-09-xxx-yyy	71
9.10	H-MD-09-xxx-yyy-EM-LL	72
9.11	H-MD-09-xxx-yyy-4C	73
9.12	H-MD-16-xxx-yyy	74
9.13	H-MD-40-921-960	75
9.14	H-MD-48-914-961	76
9.15	H-MD-09-xxxx-yyyy-8C	77
9.16	H-MD-32-9140-9605	78
9.17	ORDER INFORMATION	78
9.18	M-3840-LL	79
9.19	H-OADM1x4-xxx-yyy	80
9.20	H-OADM2x4-xxx-yyy	81
9.21	H-OADM1x4-xxx-yyy-4C	82
9.22	H-OADM2x4-xxx-yyy-4C	83
9.23	H-OADM1x2-xxx-yyy-4C	84
9.24	H-OADM2x2-xxx-yyy-4C	85
9.25	H-MD-BP1x5	86
9.26	H-MD-BP1x10	87
9.27	H-CIRC-3P	88
9.28	H-BO-1xMPO-10xLC	89

9.29	H-SB-XC-6MPO	90
9.30	H-BO-SM-1XMPO-8XLC	91
9.31	H-BO-MM-1XMPO-8XLC	92
9.32	H-D1X4	93
9.33	H-D4X4	94
9.34	H-MD-04-921-928-SFx	95
9.35	H-MD-04-929-936-SFx	96
9.36	H-MD-3155	97
9.37	H-MD-3155-HI	98
9.38	H-MD-4LAN-EM-SFx	99
9.39	H-MD-4LAN-295-309	100
9.40	H-MD-8OWDM-284-289	101
9.41	H-MD-16OWDM-284-314	102

Smartoptics makes no warranties or representations, expressed or implied, of any kind relative to the information or any portion thereof contained in this document or its adaptation or use, and assumes no responsibility or liability of any kind, including, but not limited to, indirect, special, consequential or incidental damages, for any errors or inaccuracies contained in the information or arising from the adaptation or use of the information or any portion thereof. The information in this document is subject to change without notice.

Document history

Revision	Date	Description
1.0	Nov 08, 2019	1 st released version
1.1	Nov 15, 2019	Editorial improvements and clarifications on loss calculations
2.0	Nov 24, 2019	Corrected/improved figures
2.1	Dec 12, 2019	Corrected min loss on monitor ports on H-OADM1x4-xxx-yyy and H-OADM2x4-xxx-yyy
2.2	March 09, 2020	Improved figures.
3.0	June 01, 2020	Addition of 1:5 and 1:10 Band splitter filters
4.0	Aug 27, 2020	Addition of low-loss filters and 3-port circulator
4.1	Dec 03, 2020	Updated data on 3-port circulator. Clarified usage.
5.0	Jan 14, 2021	Addition of LANWDM filters. Added information in tables.
6.0	May 07, 2021	Major rework and improvements.
6.1	Aug 27, 2021	Corrected information on location of monitor port on H-OADM1x4-xxx-yyy
7.0	Oct 08, 2021	Addition of 400G 16QAM capable DWDM Mux/Demux
7.1	Oct 11, 2021	Reduced insertion loss values on H-MD-09-xxx-yyy-EM-4C
7.2	Nov 10, 2021	Changed p/n on H-MD-09-xxx-yyy-EM-4C to H-MD-09-xxx-yyy-4C
8.0	Jan 04, 2021	Addition of H-MD-04-921-928-SFx and H-MD-04-929-936-SFx filters. Clarified loss definitions on H-CIRC-3P.
9.0	March 08, 2022	Addition of CWDM AD-filter H-AD1-C59
9.1	March 28, 2022	Changed channel passband on 400G capable filters, including intrinsic bandwidth.
9.2	April 04, 2022	Intrinsic bandwidth on H-MD-09-xxx-yyy-4C reverted to 1264-1630nm
10.0	May 18, 2022	Addition of H-OADM1x4-xxx-yyy-4C, H-OADM2x4-xxx-yyy-4C & H-OADM2x2-xxx-yyy-4C
11.0	Aug 03, 2022	Addition of CWDM AD-filters H-AD1-C47, H-AD1-C53, H-AD1-C55, H-AD1-C57, H-AD1-C61
12.0	Nov 10, 2022	Addition of LAN-WDM filter: H-MD-4LAN-295-309. Addition of Special application filters: H-SB-XC-6MPO and H-BO-1xMPO-10xLC.
12.1	March 14, 2023	Addition of H-MD-4LAN-295-309 to Technical Data
13.0	June 12, 2023	Addition of H-MD-3155-HI Addition of H-MD-8OWDM-284-298 Addition of H-MD-16OWDM-284-314
13.1	July 30, 2023	Addition of H-MD-3155-HI to Technical Data Addition of H-MD-8OWDM-284-298 to Technical Data Addition of H-MD-16OWDM-284-314 to Technical Data Addition of H-SB-XC-6MPO to Technical Data Addition of H-BO-1xMPO-10xLC to Technical Data
13.2	June 13, 2024	Updated functional image of H-MD-3155-HI in chapter 9.26 & 9.27. Addition of H-D1x4 Addition of H-D4x4 Addition of H-AD1-O-1625
13.3	Nov 4, 2024	Addition of H-09-xxxx-yyy-8C
13.4	Nov 22, 2024	Correcting of headings in the parameter overview of H-OADM2x2-xxx-yyy-4C
13.5	Jun 02, 2025	Addition of H-BO-SM-1xMPO-8xLC Addition of H-BO-MM-1xMPO-8xLC Addition of H-MD-32-9140-9605
13.6	Jul, 08, 2025	Updated technical specification of H-09-xxxx-yyy-8C
13.7	Sep, 08, 2025	Updated section 4.6, Ext port bandwidth, excl channel passband for H-MD-xxx-yyy-4C
13.8	Apr 27, 2026	Addition of H-MD-48-914-961 Addition of H-OADM-1x2-xxx-yyy-4C Addition of H-PPM-CHASSI-1 Addition of DCP-PAS-H

1 Introduction

1.1 Overview

The Smartoptics H-Series is a high-density, cost-efficient platform entailing passive optical CWDM/DWDM/LANWDM filter products.

Using best of breed components, the H-Series offers the latest generation of solutions to your passive optical networking needs. Special attention has been paid to handling, compactness and flexibility, resulting in a 1 RU chassis housing a variety of filter modules and giving you up to five times higher packaging density than earlier Smartoptics solutions.

The H-Series is fully compatible with the ITU optical grid and interconnects seamlessly with Smartoptics transponder and muxponder product lines as well as with other vendors' products.



Figure 1. H-Series

The H-Series platform comprises of a high-density 1 RU chassis that can be equipped with any combination of filter modules to meet the initial as well as future capacity needs, supporting any data rate and service type. The different modules can be combined to provide point-to-point, bus or ring topologies.

The following products are included in the H-series:

- H-CHASSI-1RU: a 19" light-weight aluminum (AL5052) chassis with 44 mounting holes that can support various module combinations.
- CWDM filters:
 - H-MD-C04L: A 4-channel Mux/DeMux low CWDM-band module.
 - H-MD-C05: A 4-channel Mux/DeMux high CWDM-band module with an extension port.
 - H-MD-C08: A 8-channel Mux/DeMux low CWDM-band module.
 - H-MD-C08L-LL: a low-loss alternative to H-MD-C08L.
 - H-MD-C09: an 8-channel Mux/DeMux high CWDM-band module with an extension port.
 - H-MD-C09H-E-LL: a low-loss alternative to H-MD-C09.
 - H-AD1-Cxx. Ten CWDM add/drop filters for e.g. OSC configurations.
 - H-AD1-O-1625. A 1625 add/dropp filter for OTDR applications.
- DWDM filters:
 - H-MD-09-xxx-yyy: five different 8ch DWDM Mux/DeMux modules with extension and monitor port.
 - H-MD-09-xxx-yyy-EM-LL: a low-loss alternative to H-MD-09-xxx-yyy.
 - H-MD-16-xxx-yyy: two different 16ch DWDM Mux/DeMux modules with extension and monitor port.
 - H-MD-40-921-960: a 40ch DWDM Mux/Demux rack mounted module. 400G 16QAM capable.
 - M3840-LL: A low-loss alternative to H-MD40-921-960.
 - H-OADM1x4-xxx-yyy: 10 different 1-way Add/Drop filters with monitor port.
 - H-OADM2x4-xxx-yyy: 10 different 2-way Add/Drop filters with monitor ports.
 - H-MD-BP1x5: 40 to 5x 8ch DWDM BandPass Filter, 921-960.
 - H-MD-BP1x10: 40 to 10x 4ch DWDM BandPass Filter, 921-960.
 - H-CIRC-3P: A 3-port DWDM circulator.
 - H-MD-04-921-928-SFx and H-MD-04-929-936-SFx single-fiber filters.
 - H-MD-09-xxx-yyy-4C; 5 different 8ch DWDM Mux/DeMux filters that are 400G 16QAM capable.
 - H-OADM1x4-xxx-yyy-4C: 10 different 1-way, 4ch OADM filters that are 400G 16QAM capable.
 - H-OADM2x4-xxx-yyy-4C: 10 different 2-way, 4ch OADM filters that are 400G 16QAM capable.
 - H-OADM1x2-xxx-yyy-4C: 20 different 1-way, 2ch OADM filters that are 400G 16QAM capable.
 - H-OADM2x2-xxx-yyy-4C: 10 different 2-way, 2ch OADM filters that are 400G 16QAM capable.
 - H-MD-09-xxxx-yyy-8C: 4 different 8ch filters with 150GHz spacing that are 800G 16QAM capable.
 - H-MD-32-9140-9605: a 32ch DWDM Mux/Demux rack mounted module. 800G 16QAM capable.
 - H-MD-48-914-961: a 48ch DWDM Mux/Demux rack mounted module. 400G 16QAM capable.

- LANWDM filters:
 - H-MD-4LAN-EM-SFx: Two MuxDemux units for 4 bi-directional 25G channels with extension port for DWDM channels over a single-fiber.
 - H-MD-4LAN-295-309: A 4ch LAN-WDM Mux/DeMux filter.
- O-Band DWDM filters:
 - H-MD-8OWDM-284-298: a 8ch O-Band DWDM Mux/Demux filter for 100G, 200GHz spaced O-Band DWDM transceivers.
 - H-MD-16OWDM-284-314: a 16ch O-Band DWDM Mux/Demux filter for 100G, 200GHz spaced O-Band DWDM transceivers.
- Special filters:
 - H-MD-3155: A 1310/1550nm band Mux/Demux unit.
 - H-MD-3155-HI: A 1310/1550nm band Mux/Demux unit, with higher isolation for amplified solutions.
 - H-SB-XC-6MPO: A MPO-12 type B filter for interconnecting the 9-Degree ROADM platform DCP-R-9D-CS
 - H-BO-1xMPO-10xLC: A MPO-12 type B to 10xLC filter for dividing the MPO-12 connector to 5 degrees, connected with LC connectors.
 - H-BO-SM- 1xMPO-8x-LC: A SingleMode MPO-12 type B to 8xLC filter for dividing the MPO-12 connector to 4 duplex LC-connectors. Suited for transceiver break-out applications.
 - H-BO-MM- 1xMPO-8x-LC: A MultiMode MPO-12 type B to 8xLC filter for dividing the MPO-12 connector to 4 duplex LC-connectors. Suited for transceiver break-out applications.
 - H-D1x4: A dual 1x4 splitter/combiner unit to achieve CDC ROADM applications
 - H-D4x4: A dual 4x4 splitter/combiner unit to achieve CDC ROADM applications

The H-Series filters are passive devices and can be placed in locations without electrical power. They are also vendor solution independent since no SW integration is required. The H-Series filters (apart from the 40ch units) support the industrial temperature range of -40°C to +85°C (-40°F to +185°F) which gives an extended application range into sites without sufficient temperature control.

Filters having “LL” in the part number are filters using a more advanced filter design to provide a lower loss. As an example, H-MD-C08L-LL is a low loss version of H-MD-C08.

Filters having “-4C” in the part number are filters that have a wider channel passband to support 400G 16QAM signals.



The H-Series filters are mounted in a 1 RU mounting bracket solution where the filter module sizes vary depending on type of filter, i.e. the number of optical ports that are required. The filters are thus not wider than necessary. The size of the plug-in filter units runs from 35 to 113mm in width and any combination of the filter modules can be mounted in the 422mm wide slot of the mounting bracket. The 40ch filters are monoliths and have a full 19” rack width.



H-Series mounting brackets with different filter modules.



H-Series 40ch monolith.

2 Technology basics

Normally we talk about two types of wavelength multiplexing technologies: CWDM and DWDM. However, recently a new band has emerged in the 1300nm region, called LANWDM. Four LANWDM channels are used as lane wavelengths for the 4x 25Gbps signals in e.g. 100GBASE-LR4 interfaces. These LANWDM channels have been extended to eight channels and can be found in SFP28 transceivers for 25G Ethernet and CPRI signals in 5G networks. The main reason is to benefit from the zero-dispersion region of the SM-fiber. The number of LANWDM used channels is currently eight, but additional are being defined in the industry.

The below figure shows the location of the three bands.

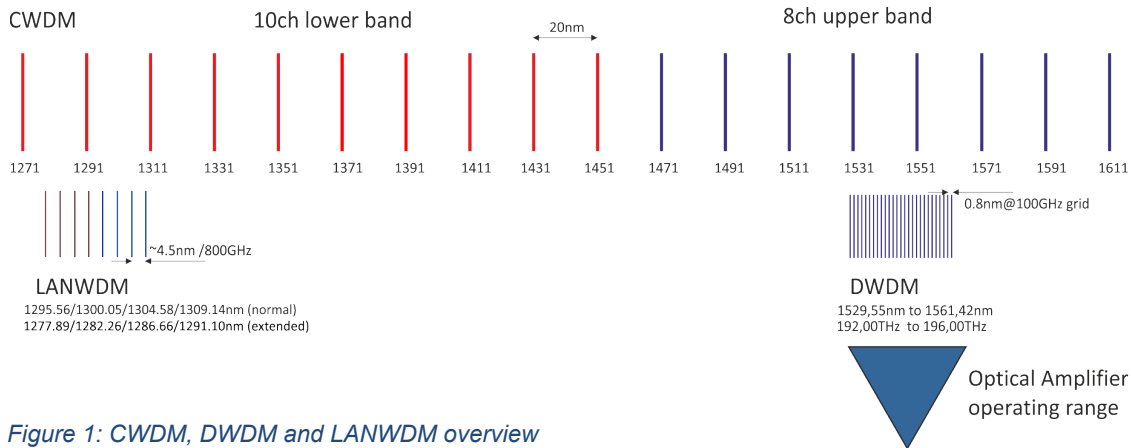
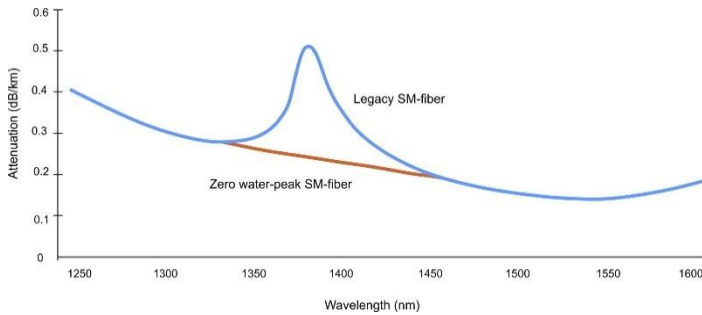
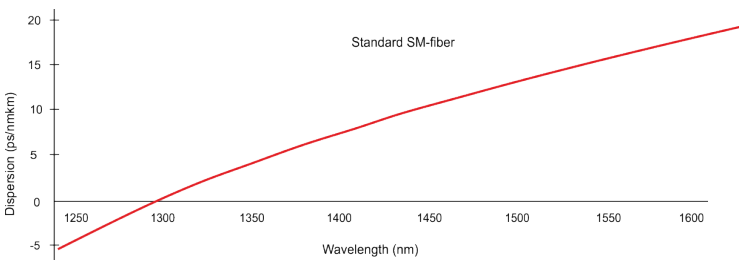

Figure 1: CWDM, DWDM and LANWDM overview

There are in essence two factors that will limit the bridgeable distance for an optical signal carried on a fiber: attenuation and dispersion. So you have a dispersion limit and an attenuation limit to take into account.



This figure below shows the typical wavelength dependent attenuation for SM-fiber. Measured as dB/km.



This figure shows the typical wavelength dependent dispersion of a SM-fiber. Measured as ps/nm*km

When these curves are added to the LANWDM, CWDM and DWDM channels one can conclude that the low band CWDM and LANWDM channels are burdened by the intrinsic higher fiber attenuation. The high band CWDM and DWDM channels see less attenuation but are instead burdened by higher dispersion.

Attenuation is bit rate independent and increases with fiber distance, connectors, splices and optical filters. Dispersion increases with distance and its impact is worsened with increasing bit rate.

Attenuation can be compensated by using an optical amplifier. These only work in the 1550nm region, i.e. where the DWDM channels are placed. So LANWDM and CWDM channels cannot use standard EDFA amplifiers. Using transceivers with a high power budget (Min Tx power to Rx sensitivity) and low loss filters are the two options to fight attenuation when amplifiers cannot be used.

Note also the water-peak attenuation that exist in legacy G.652 fibers. Many CWDM Mux/Demuxes skip the channels most affected by this water-peak. So the low CWDM-band is typically reduced to 8 channels. The newer G.652D SM-fiber version is mostly deployed today since it has the water-peak is removed.

Dispersion can be compensated using special dispersion compensation components. These add on attenuation and typically optical amplifiers are needed to compensate for this extra loss. Again, this is only applicable on DWDM channels. The impact of fiber dispersion can be reduced by using spectrally "clean" lasers. Such transceivers have typically a higher price tag since the laser is more advanced.

To conclude:

- CWDM and LANWDM solutions are attenuation and/or dispersion limited since optical amplification and dispersion compensation typically cannot be applied. It is thus important to measure the actual characteristics (such as attenuation and dispersion) of the actual link and check the power budget and dispersion limit of the used transceivers to determine how many channels that can be deployed and what distance that can be bridged.
- Un-amplified DWDM solutions have same limitations as CWDM and LANWDM solutions.
- Amplified DWDM solutions can compensate for attenuation and dispersion, but then optical noise will emerge as the limiting factor.

Passive networks can be calculated via simple additions and subtractions. Amplified networks require more advanced design tools.

Note! 400G wavelengths using coherent 16QAM modulation can operate in 100GHz grid configurations, but the signal requires a wider channel bandwidth as compared to lower bit rates. 400G 16QAM signals will thus be heavily affected when driven through standard DWDM filters that are not specifically designed to have a wider channel bandwidth.

3 H-Series CWDM-filters

3.1 Overview

The CWDM-band can be divided into a low channel band (1271nm to 1451nm) and a high channel band (1471nm to 1611nm). The wavelength grid is at 20nm separation as defined in the ITU-T standard G.694.2. CWDM channels can only be carried on single-mode fibers.

CWDM channels are carried on single-mode fibers where the lower CWDM channel band faces a higher intrinsic attenuation and many older fibers have also a high attenuation area (called “water-peak”). These two together will typically limit the bridgeable distance for low-band CWDM channels. The Smartoptics CWDM filters skip the two channels most affected by the water-peak. So the low CWDM-band is reduced to 8 channels.

For longer distances or where the link attenuation is high, a CWDM solution could be limited to using the high CWDM channel band where the intrinsic fiber attenuation is lower. Here the dispersion could be the limiting factor instead.

Six CWDM Mux/Demux filters and three Add/drop filters are currently provided within the H-Series;

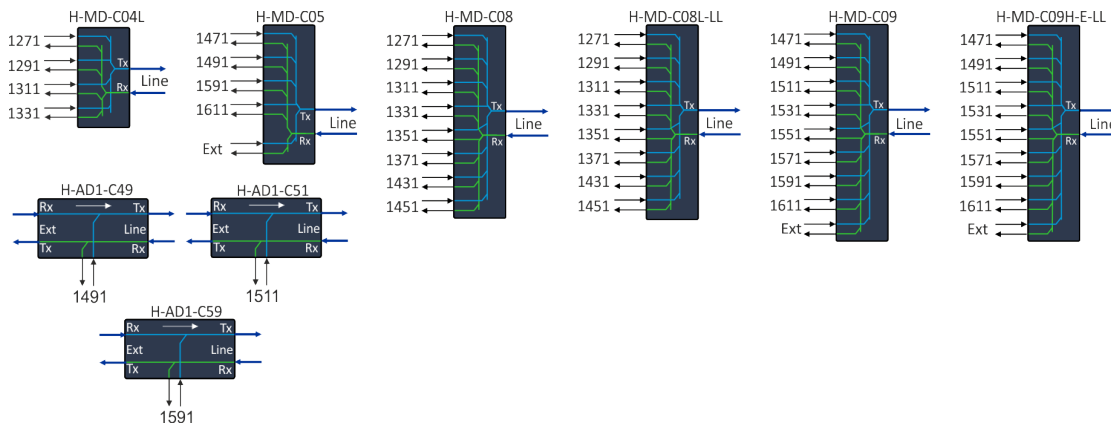

Figure 2: H-Series CWDM filters

These filters are described further in the chapters below. For technical data, see chapter 9.

Note! The CWDM channels are according to the ITU-T G.694.1 located at 1271nm, 1291nm etc at 20nm spacing. The CWDM channels are also (for historical reasons) called “1270nm”, “1290nm” etc. The actual wavelengths are always according to ITU-T G.694.1 regardless of used label/name.

3.2 H-MD-C04L; 4ch low CWDM-band filter

H-MD-C04L is a CWDM Mux/Demux covering the lower CWDM channels 1271 to 1331nm.

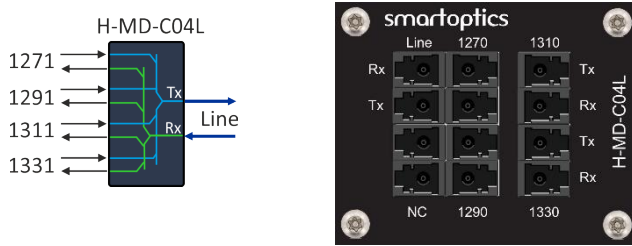

The filter module is 55mm wide.

Figure 3: H-MD-C04L logical icon and front plate

The H-MD-C04L can as an example be used in 400G to 4x 100G breakout configurations as shown in the figure below. The 400G LR4 or FR4 signals consists of four 100Gbps lanes carried on these CWDM channels. The extracted 100Gbps signals are connected to the corresponding 100G single-lambda LR or FR transceivers.

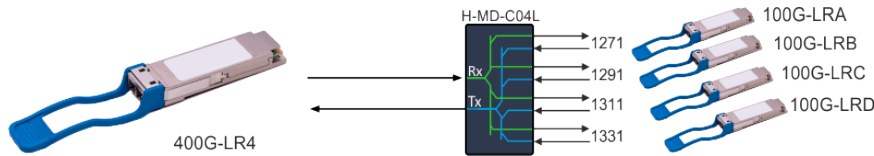

Figure 4: 400G to 4x 100G breakout

H-MD-C04L can also be used to multiplex 4x 100G channels via the single-lambda 100G transceivers SO-QSFP28-100G-FRx and SO-QSFP28-100G-LRx that are available in these CWDM channels.

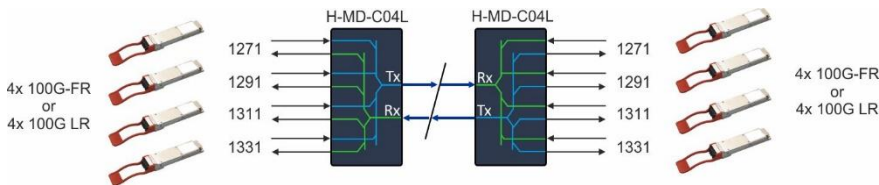

Figure 5: 4x 100G over CWDM

The above example configurations are typically seen in datacenters where density is of prime importance. The H-Series provides a compact configuration via multiple H-MD-C04L filters in the 1RU mounting bracket.

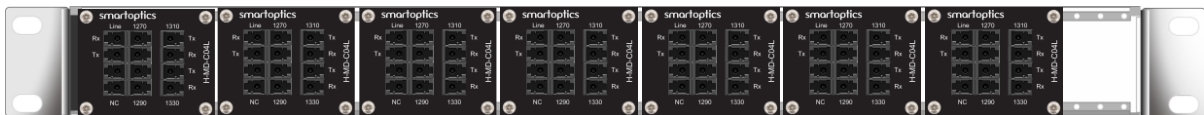

Figure 6: H-Series brackets with 7x H-MD-C04L CWDM filters

The table lists selected (worst case) parameters at I-temp conditions.

PARAMETER	H-MD-C04L
Link loss, Ch Rx ⇒ Line Tx ⇒ Line Rx ⇒ Ch Tx	≤ 2.2dB

For more technical data, see chapter 9.

3.3 H-MD-C05; 4ch high CWDM-band filter

The H-MD-C05 is a 4ch high CWDM-band Mux/DeMux with an Extension port.

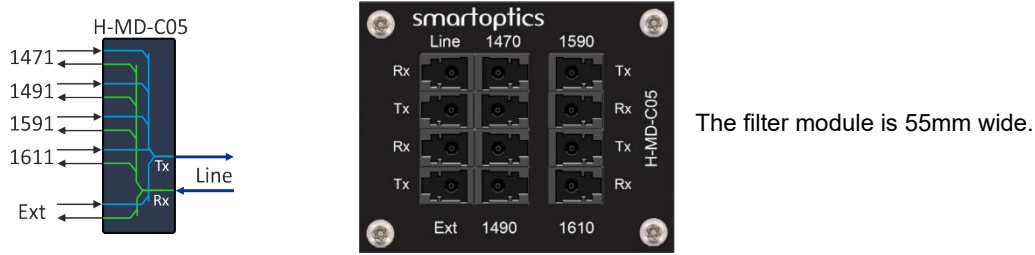

Figure 7: H-MD-C05 logical icon and front plate

The four wavelength ports of the H-MD-C05 operates on the high CWDM-band channels; 1471/1491nm & 1591/1611nm. The wavelength band between these can be utilized for DWDM channels via the Extension port. This is the primary intension with this filter. To fully utilize the high band CWDM channels, the H-MD-C09 or H-MD-C09H-E-LL is the recommended choice.

Alternatively, the low CWDM-band channels can be added to the Extension port via the H-MD-C08 or H-MD-C08L-LL Mux/DeMux modules to provide an 8+4 channel solution. The Extension port can as another alternative be connected to a fiber network carrying a legacy 1300nm channel, enabling the same fiber infrastructure to carry an additional four channels. Figure 6 shows channels supported via the wavelength ports (λ-ports) and Extension port.

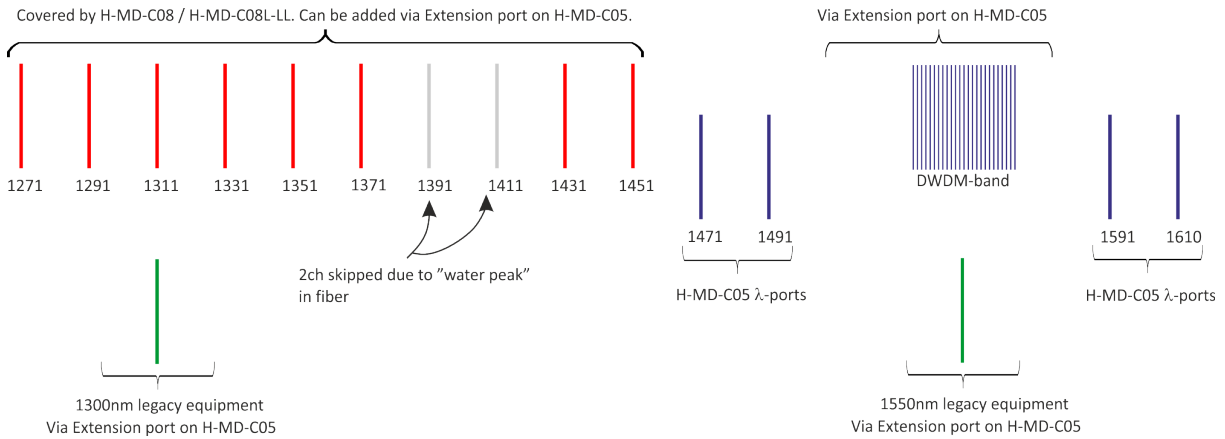

Figure 8: H-MD-C05 channels overview

The figure below shows how the H-MD-C05 filters are combined with the 8ch H-MD-C08 or H-MD-C08L-LL filters to provide a 4+8 channel configuration.

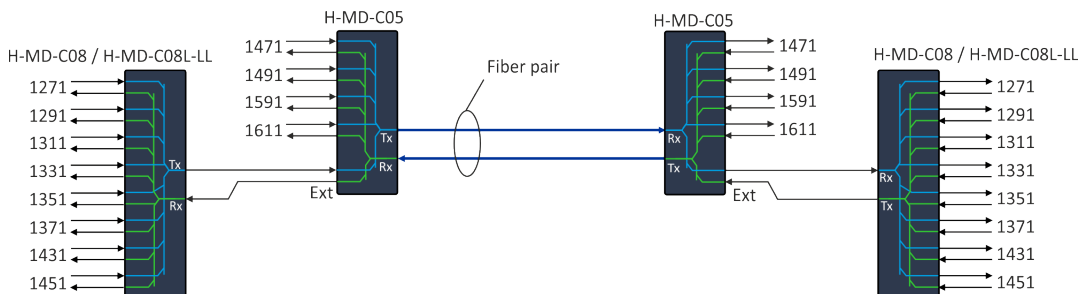

Figure 9: H-MD-C05 combined with H-MD-C08 or H-MD-C08L-LL

The H-MD-C05 filters need not be in the same location as the low CWDM-band filters. They can be placed in different racks within a site to ease fiber management. The attenuation of the patch cords between the H-MD-C05 and low band filters must be taken into account if the distance is long enough to make that relevant.

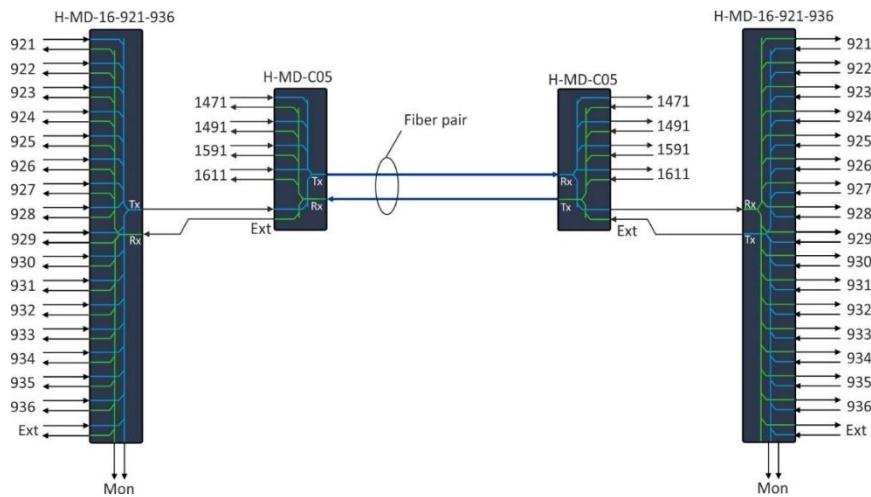

Figure 10: Combined CWDM and DWDM configuration example

The figure above shows the alternative example where the H-MD-C05 filters are combined with DWDM channels via the H-MD-16-921-936 filters. In the case that optical EDFA amplifiers are required, these are added between the DWDM and CWDM filters so that only the DWDM channels are amplified.

The table lists selected (worst case) parameters at I-temp conditions.

PARAMETER	H-MD-C05	
Link loss, Ch Rx ⇒ Line Tx ⇒ Line Rx ⇒ Ch Tx	≤ 3.0dB	Loss values at I-temp conditions.
Link loss Ext Rx ⇒ Line Tx ⇒ Line Rx ⇒ Ext Tx	≤ 3.6dB	Lower values apply at C-temp. See technical data in chapter 8.

See chapter 9 for additional technical data.

The table lists what filters that can be connected to the Extension port.

PARAMETER	
Extension port wavelength bands H-MD-C05	1260 – 1464nm / 1498 – 1584nm / 1618 – 1620nm
Filters matching Ext port	H-MD-C04L (CWDM channels 1271 – 1331nm)
	H-MD-C08 (CWDM channels 1271 – 1451nm)
	H-MD-C08L-LL (CWDM channels 1271 – 1451nm)
	H-MD-09-xxx-yyy (DWDM channels 921 – 960 / 529.55 – 1560.61nm)
	H-MD-09-xxxxyy-EM-LL (DWDM channels 921 – 960 / 529.55 – 1560.61nm)
	H-MD-16-xxx-yyy (DWDM channels 921 – 952 / 1535.82 – 1560.61nm)
	H-MD-40-921-960 (DWDM channels 921 – 960 / 1529.55 – 1560.61nm)
	H-MD-48-914-961 (DWDM channels 914 – 961 / 1528.77 – 1566.31nm)
M-3840-LL (DWDM channels 921 – 960 / 1529.55 – 1560.61nm)	

3.4 H-MD-C08; 8ch low CWDM-band filter

The H-MD-C08 is an 8ch low CWDM-band Mux/DeMux. The eight wavelength ports of the H-MD-C08 operates on the low CWDM-band channels; 1271 to 1451nm.

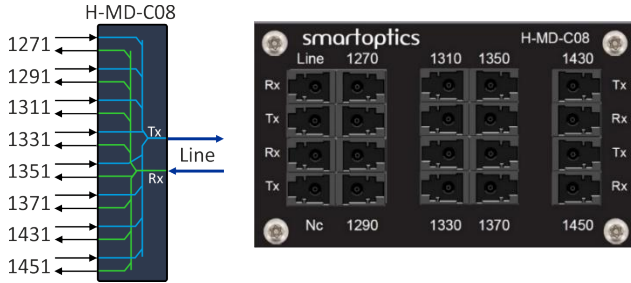

The filter module is 75mm wide.

Figure 11: H-MD-C08 logical icon and front plate

As seen in the figure below, the two channels 1391 and 1411nm are skipped since these are subject to the high water-peak attenuation that can be present in older fiber types.

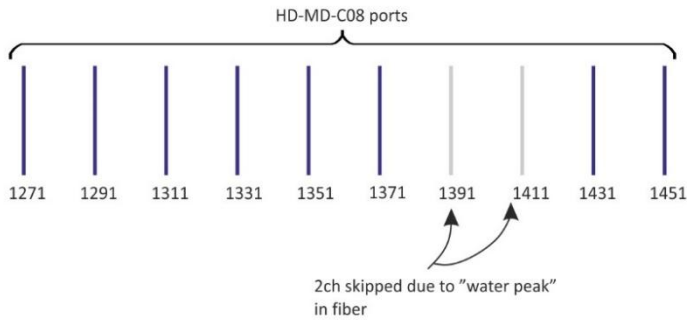

Figure 12: H-MD-C08 channels

The H-MD-C08 can be used stand-alone or be combined via the Extension port of other CWDM filters such as the H-MD-C05, H-MD-C09 or H-MD-C09H-E-LL filters. Each filter having an Extension port have a table listing supported filters.

The table compares the worst case (ageing & temperature) link loss of H-MD-C08 and H-MD-C08L-LL at I-temp conditions. See chapter 9 for additional technical data.

PARAMETER	H-MD-C08	H-MD-C08L-LL	Loss values at I-temp conditions.
Link loss, Ch Rx ⇒ Line Tx ⇒ Line Rx ⇒ Ch Tx	≤ 4.2dB	≤ 3.2dB	Lower values apply at C-temp. See technical data in chapter 8.

H-MD-C08L-LL uses a more expensive filter design to provide a lower loss. The selection between the two is a balance between needed loss and cost.

3.5 H-MD-C08L-LL; 8ch low-loss, low CWDM-band filter

H-MD-C08L-LL has the exact same channel coverage as the H-MD-C08 but has a different filter design to provide lower losses. H-MD-C08L-LL can thus be a better/necessary choice in networks with higher losses, stretched distances or networks with cascaded filters. H-MD-C08 is a more cost-effective choice where its losses are within the requirements. For technical data, see chapter 9.

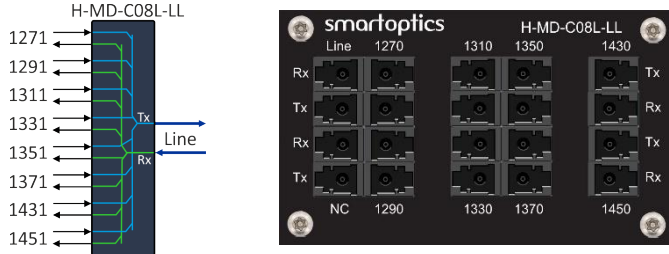

The filter module is 75mm wide.

Figure 13: H-MD-C08L-LL logical icon and front plate

As seen in the figure below, the two channels 1391 and 1411nm are skipped since these are subject to the high water-peak attenuation that can be present in older fiber types.

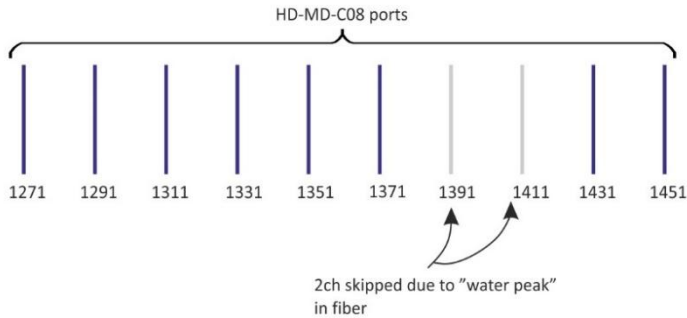

Figure 14: H-MD-C08L-LL channels

The H-MD-C08 can be used stand-alone or be combined via the Extension port of other CWDM filters such as the H-MD-C05, H-MD-C09 or H-MD-C09H-E-LL filters. Each filter having an Extension port have a table listing supported filters.

The table compares the worst case (ageing & temperature) link loss of H-MD-C08 and H-MD-C08L-LL at I-temp conditions. See chapter 9 for additional technical data.

PARAMETER	H-MD-C08	H-MD-C08L-LL	Loss values at I-temp conditions.
Link loss, Ch Rx ⇒ Line Tx ⇒ Line Rx ⇒ Ch Tx	≤ 4.2dB	≤ 3.2dB	Lower values apply at C-temp. See technical data in chapter 8.

H-MD-C08L-LL uses a more expensive filter design to provide a lower loss. The selection between the two is a balance between needed loss and cost.

3.6 H-MD-C09; 8ch high CWDM-band filter

The H-MD-C09 is an 8ch CWDM Mux/DeMux with an extension port. The eight wavelength ports of the H-MD-C09 operates on the high CWDM-band channels; 1471 to 1611nm. This filter is best used to fully utilize the upper CWDM channels in the region where the SM fiber attenuation is the lowest.

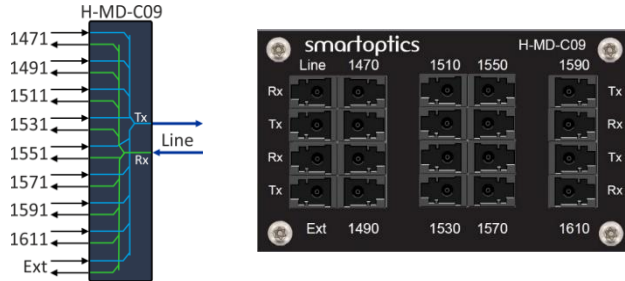

The filter module is 75mm wide.

Figure 15: H-MD-C09 logical icon and front plate

As shown in the figures below, the extension port can be used to add on the low CWDM channel band via the H-MD-C04L, H-MD-C08 or H-MD-C08L-LL Mux/DeMux'es.

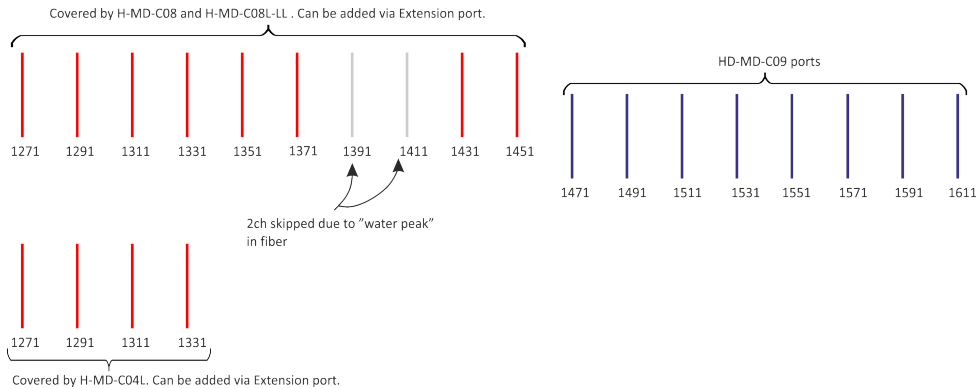

Figure 16: H-MD-C09 channels and potential added low CWDM-band channels

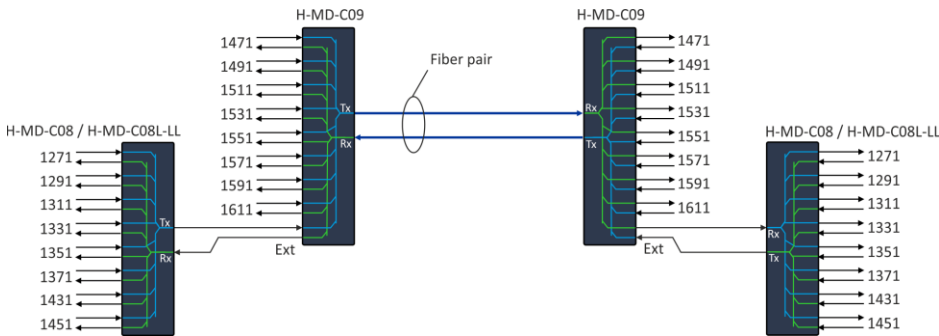

Figure 17: Example with H-MD-C09 combined with 8ch CWDM low band filters

The H-MD-C09 filters need not be in the same location as the H-MD-C08/ H-MD-C08L-LL filters. They can be placed in different racks within a site to ease fiber management. The attenuation of the patch cords between the H-MD-C09 and H-MD-C08/ H-MD-C08L-LL filters must be taken into account if the distance is long enough to make that relevant.

The table lists what filters that can be connected to the Extension port.

PARAMETER	
Extension port wavelength band H-MD-C09	1264 – 1458nm
Filters matching Ext port	H-MD-C04L (CWDM channels 1271 – 1331nm)
	H-MD-C08 (CWDM channels 1271 – 1451nm)
	H-MD-C08L-LL (CWDM channels 1271 – 1451nm)

The table below compares the worst-case (ageing & temperature) link loss of H-MD-C09 and H-MD-C09H-E-LL at I-temp conditions. Note that C-temp conditions will provide lower losses. See chapter 9 for additional technical data.

It also shows the worst-case link loss for a channel going through a low CWDM-band Mux/Demux via the Extension ports of the high-band Mux/Demux'es.

PARAMETER	H-MD-C09	H-MD-C09H-E-LL
Link loss, Ch Rx ⇒ Line Tx ⇒ Line Rx ⇒ Ch Tx	≤ 4.5dB	≤ 3.4dB
Link loss, Ext Rx ⇒ Line Tx ⇒ Line Rx ⇒ Ext Tx	≤ 7.0dB	≤ 1.8dB
Link loss, channel H-MD-08 via Ext ports	≤ 11.2dB	≤ 6.0dB
Link loss, channel H-MD-C08L-LL via Ext ports	≤ 10.2dB	≤ 4.6dB
Link loss, channel H-MD-04L via Ext ports	≤ 9.2dB	≤ 4.0dB

Loss values at I-temp conditions.
Lower values apply at C-temp. See technical data in chapter 8.

The -LL filters use a more expensive filter design to provide a lower loss. The selection is a balance between needed loss and cost.

3.7 H-MD-C09H-E-LL; 8ch low loss, high CWDM-band filter

H-MD-C09H-E-LL has the exact same channel coverage as the H-MD-C09 but has a different filter design to provide lower losses. H-MD-C09H-E-LL can thus be a better/necessary choice in networks with higher losses, stretched distances or networks with cascaded filters. H-MD-C09 is a more cost-effective choice where its losses are within the requirements.

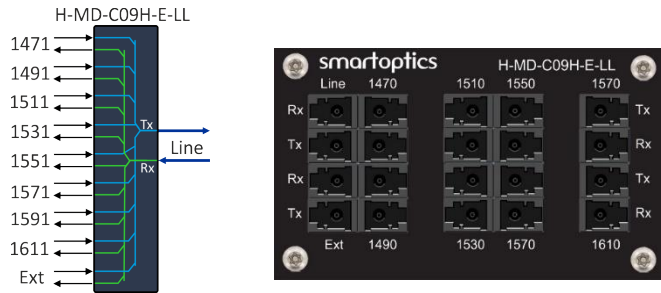

The filter module is 75mm wide.

Figure 18: H-MD-C09H-E-LL logical icon and front plate

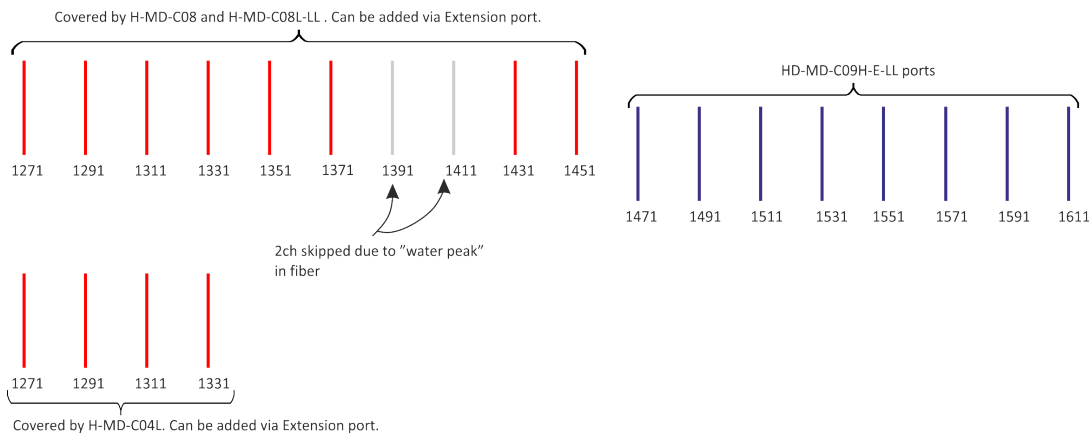

Figure 19: H-MD-C09H-E-LL channels and added channels via Extension port

The table lists what filters that can be connected to the Extension port.

PARAMETER	
Extension port wavelength band H-MD-C09H-E-LL	1264 – 1458nm
Filters matching Ext port	H-MD-C04L (CWDM channels 1271 – 1331nm)
	H-MD-C08 (CWDM channels 1271 – 1451nm)
	H-MD-C08L-LL (CWDM channels 1271 – 1451nm)

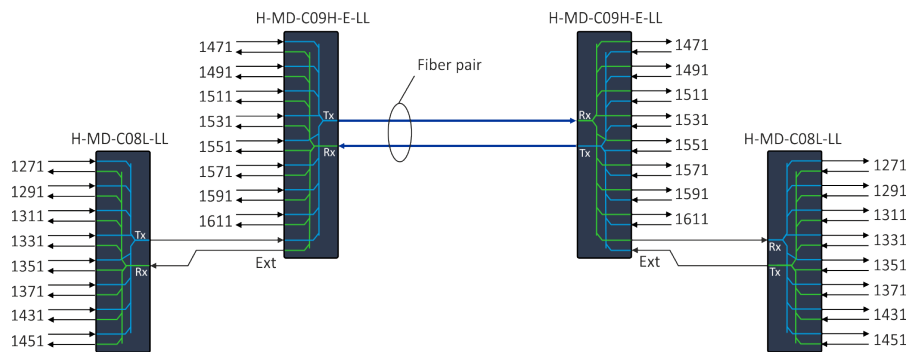

Figure 20: H-MD-C09H-E-LL combined with the H-MD-C08L-LL filters to provide an 8+8 channel configuration

The table below compares the worst-case (ageing & temperature) link loss of H-MD-C09 and H-MD-C09H-E-LL at I-temp conditions. Note that C-temp conditions will provide lower losses. See chapter 9 for additional technical data.

It also shows the worst-case link loss for a channel going through a low CWDM-band Mux/Demux via the Extension ports.

PARAMETER	H-MD-C09	H-MD-C09H-E-LL
Link loss, Ch Rx ⇒ Line Tx ⇒ Line Rx ⇒ Ch Tx	≤ 4.5dB	≤ 3.4dB
Link loss, Ext Rx ⇒ Line Tx ⇒ Line Rx ⇒ Ext Tx	≤ 7.0dB	≤ 1.8dB
Link loss, channel H-MD-08 via Ext ports	≤ 11.2dB	≤ 6.0dB
Link loss, channel H-MD-C08L-LL via Ext ports	≤ 10.2dB	≤ 4.6dB
Link loss, channel H-MD-04L via Ext ports	≤ 9.2dB	≤ 4.0dB

Loss values at I-temp conditions.
Lower values apply at C-temp. See technical data in chapter 8.

The -LL filters use a more expensive filter design to provide a lower loss. The selection is a balance between needed loss and cost.

3.8 H-AD1-Cxx; 1ch CWDM AD-filters

The H-AD1-Cxx are CWDM Add-drop filter modules covering the CWDM channels from 1311nm to 1625nm. The typical application is for OSC and/or OTDR configurations in DWDM line systems. Below are fronts and icons of H-AD1-C49, H-AD1-C51 and H-AD1-C59.

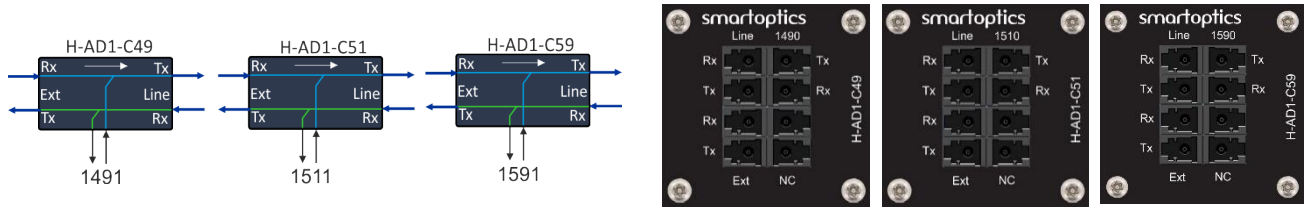

Figure 21: H-AD1-Cxx logical icons and front plates

The filter modules are 45mm wide.

The Line-ports shall always face inwards a connection as shown in the figure below.



Figure 22: H-AD1-C49 connection example

The table lists selected (worst case) parameters at I-temp conditions.

PARAMETER	H-AD1-CXX
Link loss, channel Ch Rx ⇒ Line Tx ⇒ Line Rx ⇒ Ch Tx	≤ 1.7dB
Pass-through loss Ext Rx ⇒ Line Tx	≤ 0.8dB
Pass-through channel band (excl a/d channel)	1260 – 1620nm

Loss values at I-temp conditions.

Lower values apply at C-temp. See technical data in chapter 8.

See chapter 9 for additional technical data.

3.9 H-AD1-O-1625; 1ch OTDR AD-filter

The H-AD1-O-1625 is a Add-drop filter modules covering the wavelength 1625nm. The typical application is for OTDR configurations in DWDM line systems. Below are fronts and icons of H-AD1-O-1625.

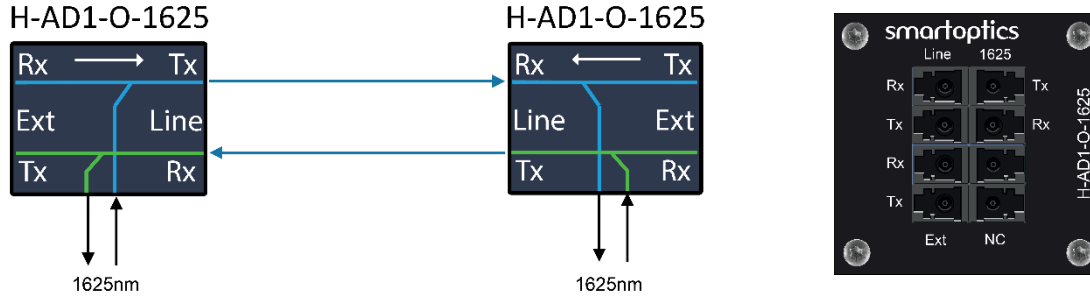

Figure 23: H-AD1-Cxx logical icons and front plates

The table lists selected (worst case) parameters at I-temp conditions.

PARAMETER	H-AD1-CXX
Rx, 1625 ⇒ Line Tx ⇒ Line Rx ⇒ Tx, 1625	≤ 1.8dB
Pass-through loss Ext Rx ⇒ Line Tx	≤ 0.6dB
Pass-through channel band (excl a/d channel)	1260 – 1582nm
Add/Drop channel band	1600 – 1670nm

Loss values at I-temp conditions.

Lower values apply at C-temp. See technical data in chapter 8.

See chapter 9 for additional technical data.

4 H-Series DWDM-filters

4.1 Overview

The DWDM band can be divided into many bands, but the most used is the C-band (1530nm – 1565nm) where you have the lowest fiber attenuation and where standard optical EDFA amplifiers can be used.

Different channel grids are defined by ITU-T in recommendation G.692.1 and the actual selection is based on a balance of e.g. cost, modulation techniques and bit/ baud rates.

A channel spacing of 100GHz is perhaps the most commonly used in the industry since the cost profile of the involved components (optical transceivers, filters etc.) are lower as compared to 50GHz components. High capacity links will however require denser channel grids and also extend into the adjacent L-band (1565nm – 1625nm) to provide additional channels.

The H-Series DWDM filters are focused on the 100GHz grid technology to provide a cost and capacity profile that is optimized for metro and access applications.

Note! 400G wavelengths using coherent 16QAM modulation can operate in 100GHz grid configurations, but the signal requires a wider channel bandwidth as compared to lower bit rates. 400G 16QAM signals will thus be heavily affected when driven through standard DWDM filters that are not specifically designed to have a wider channel bandwidth. H-MD40-921-960 is a 40ch DWDM filter that has this wider channel bandwidth and can be used in 400G 16QAM configurations.

The H-Series DWDM portfolio consists of:

- H-MD-09-xxx-yyy: five different 8ch DWDM Mux/DeMux modules with extension and monitor port.
- H-MD-09-xxx-yyy-EM-LL: a low-loss alternative to H-MD-09-xxx-yyy.
- H-MD-16-xxx-yyy: two different 16ch DWDM Mux/DeMux modules with extension and monitor port.
- H-MD-40-921-960: a 40ch DWDM Mux/Demux rack mounted module
- H-MD-48-914-961: a 48ch DWDM Mux/Demux rack mounted module
- M3840-LL: A low-loss alternative to H-MD40-921-960.
- H-OADM1x4-xxx-yyy: 10 different 1-way Add/Drop filters with monitor port.
- H-OADM2x4-xxx-yyy: 10 different 2-way Add/Drop filters with monitor ports.
- H-MD-BP1x5: 40 to 5x 8ch DWDM BandPass Filter, 921-960.
- H-MD-BP1x10: 40 to 10x 4ch DWDM BandPass Filter, 921-960.
- H-CIRC-3P: A 3-port DWDM circulator.
- H-MD-04-921-928-SFx and H-MD-04-929-936-SFx single-fiber filters.
- H-MD-09-xxx-yyy-4C; 5 different 8ch DWDM Mux/DeMux filters that are 400G 16QAM capable.
- H-OADM1x4-xxx-yyy-4C: 10 different 1-way, 4ch OADM filters that are 400G 16QAM capable.
- H-OADM2x4-xxx-yyy-4C: 10 different 2-way, 4ch OADM filters that are 400G 16QAM capable.
- H-OADM1x2-xxx-yyy-4C: 20 different 1-way, 2ch OADM filters that are 400G 16QAM capable.
- H-OADM2x2-xxx-yyy-4C: 10 different 2-way, 2ch OADM filters that are 400G 16QAM capable.
- H-MD-09-xxxx-yyy-8C: 4 different 8ch filters with 150GHz spacing that are 800G 16QAM capable.

These filters are described further in the chapters below. For technical data, see chapter 9.

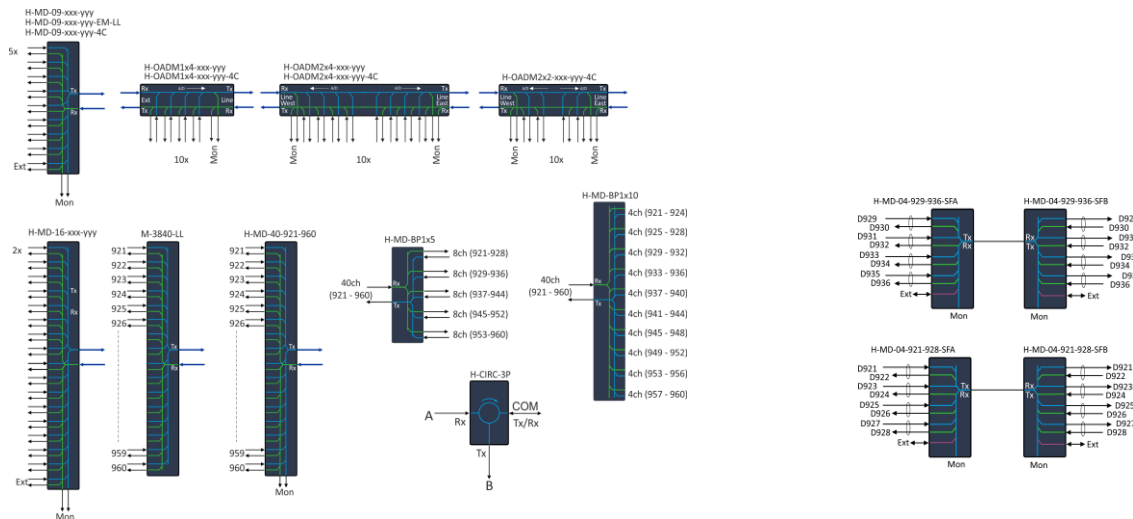
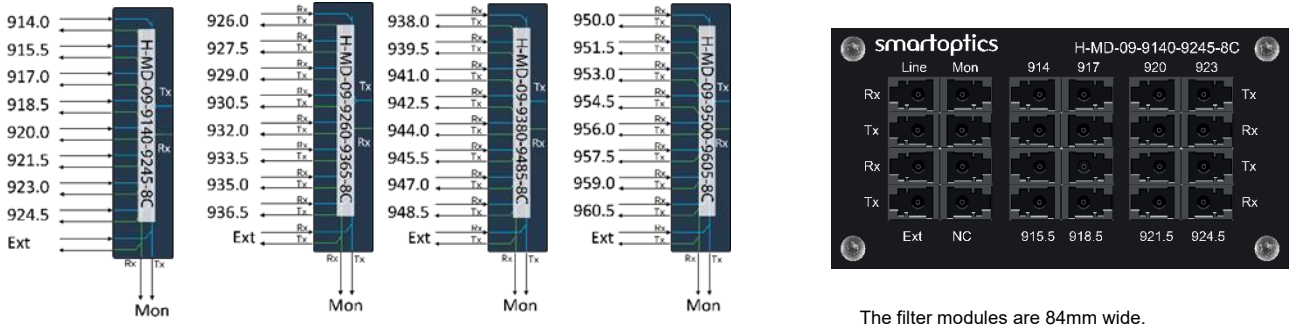

Figure 24: DWDM filters

4.2 H-MD-09-xxxx-yyyy-8C; 800G 8ch DWDM filter

The H-MD-09-xxxx-yyyy-8C are a set of 8ch DWDM filters covering channels 191.4 to 196.05THz with a channel passband of 135.0GHz enabling 800Gbps/16QAM-PCS signals to be add/dropped. The pass-through (Ext ↔ Line) has coverage of 1520 – 1620nm, covering the C-Band.



The filter modules are 84mm wide.

Figure 25: H-MD-09-xxx-yyy-8C logical icons and front plate example

The monitor ports tap off about 1% of the transmitted and received line signal. This provides the ability to monitor the channel power levels via a connected Optical Channel Monitoring (OCM) device or an optical spectrum analyzer.

The table below lists the provided variants:

ORDERING CODE	DWDM CHANNELS
H-MD-09-9140-9245-8C	191.4 to 192.45 THz
H-MD-09-9260-9365-8C	192.6 to 193.65 THz
H-MD-09-9380-9485-8C	193.8 to 194.85 THz
H-MD-09-9500-9605-8C	195.0 to 196.05 THz

The number of channels can be extended by connecting two or more filters via the Extension ports. The filters can be combined in any order i.e. need not be connected in consecutive channel order.

PARAMETER	H-MD-C09-xxx-yyy
Link loss, Ch Rx ⇒ Line Tx ⇒ Line Rx ⇒ Ch Tx	≤ 5.2dB
Link loss, Ext Rx ⇒ Line Tx ⇒ Line Rx ⇒ Ext Tx	≤ 5.4dB
Link loss, (Ch Rx ⇒ Line Tx) ⇒ (Ext Rx ⇒ Line Tx ⇒ Line Rx ⇒ Ext Tx) ⇒ (Line Rx ⇒ Ch Tx)	≤ 10.6dB
Ext port bandwidth, excl channel passband	1520-1620nm

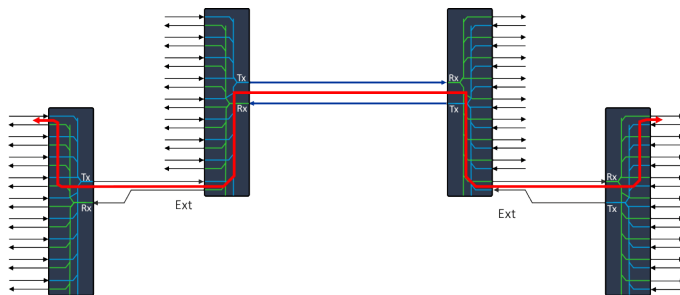

Note:
Loss values at I-temp conditions.
Lower values apply at C-temp. See technical data in chapter 8.

Link loss, (Ch Rx ⇒ Line Tx) ⇒ (Ext Rx ⇒ Line Tx ⇒ Line Rx ⇒ Ext Tx) ⇒ (Line Rx ⇒ Ch Tx)

For technical data, see chapter 9.

4.3 H-MD-32-9140-9605; 800G 32ch DWDM filter

The H-MD-32-921-960 filter is a 32-channel DWDM protocol transparent Mux/Demux unit in accordance with 150GHz grid. The channels operate in the standard C-band in dual fiber working configuration. The H-MD-32-9140-9605 has two Monitor ports that tap off 1% of the transmitted and received line signal. This provides the ability to monitor the channel power levels via a connected Optical Channel Monitoring (OCM) device or an optical spectrum analyzer.

The H-MD-32-9140-9605 is based on athermal AWG technology and is totally passive. This technology is restricted to -5 to +65oC operating temperature.

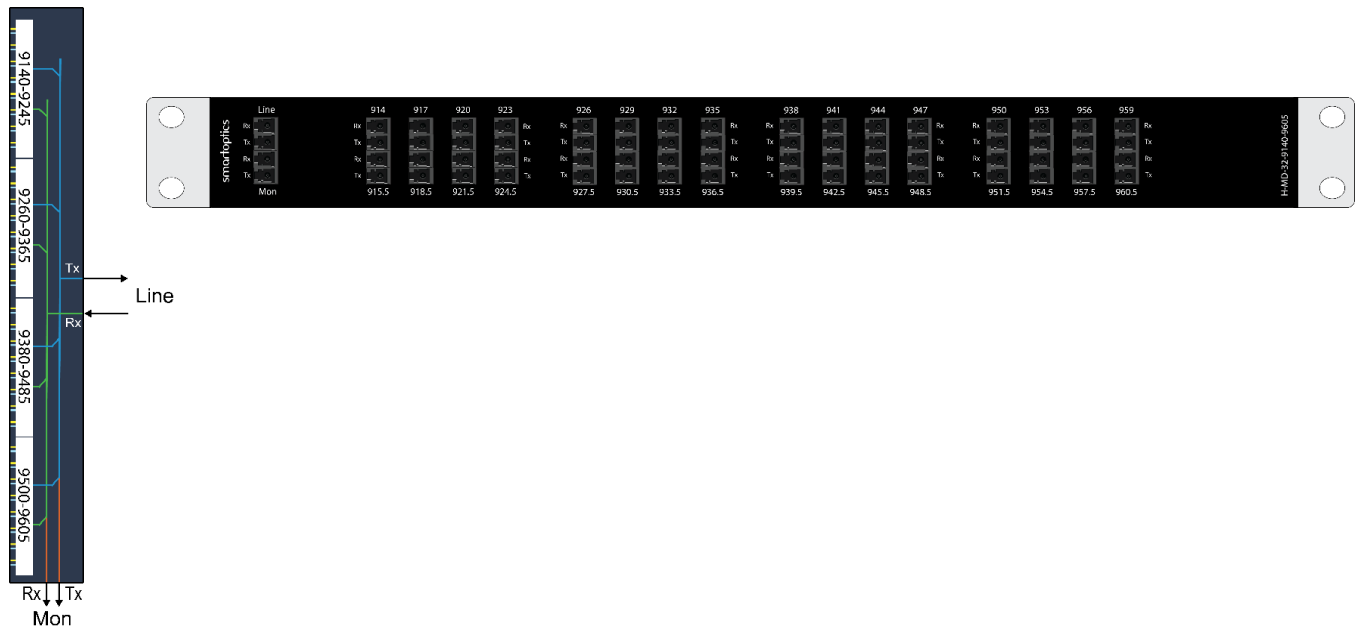

Figure 26: H-MD-32-9140-9605 icon and front plate

The passband of the H-MD-32-9140-9605 is wider to fit 800G DP-16QAM signals. For technical data, see chapter 9.

PARAMETER	H-MD-32-9140-9605
Link loss, Ch Rx ⇒ Line Tx ⇒ Line Rx ⇒ Ch Tx	≤ 12.0dB
Channel bandwidth (-3dB)	≥ 150GHz

Note:

Maximum insertion loss difference from the mean transmission at the 150GHz grid wavelength to the highest power, all polarizations, within the band of the two adjacent channels.

Total cumulative insertion loss difference from the mean transmission at the 150GHz grid wavelength to the highest power, all polarizations, within the band of the two adjacent channels.

4.4 H-MD-09-xxx-yyy; 8ch DWDM filter

The H-MD-09-xxx-yyy filters are a series of DWDM Mux/DeMux'es having 8 wavelength ports, one extension port and two monitor ports.

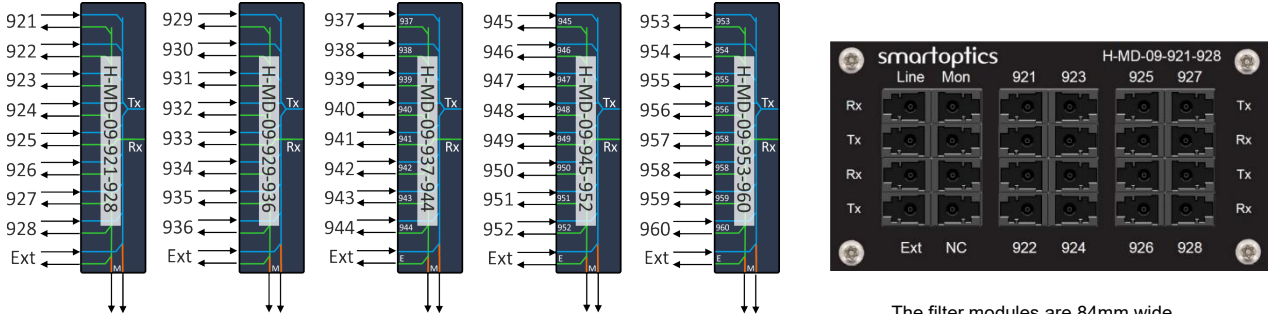

The filter modules are 84mm wide.

Figure 27: H-MD-09-xxx-yyy logical icons and front plate example

The monitor ports tap off about 1% of the transmitted and received line signal. This provides the ability to monitor the channel power levels via a connected Optical Channel Monitoring (OCM) device or an optical spectrum analyzer. For technical data, see chapter 9.

The table below lists the provided variants:

ORDERING CODE	DWDM CHANNELS
H-MD-09-921-928	192.1 to 192.8 THz
H-MD-09-929-936	192.9 to 193.6 THz
H-MD-09-937-944	193.7 to 194.4 THz
H-MD-09-945-952	194.5 to 195.2 THz
H-MD-09-953-960	195.3 to 196.0 THz

The number of channels can be extended by connecting two or more filters via the Extension ports. The filters can be combined in any order i.e. need not be connected in consecutive channel order as shown in Figure 36.

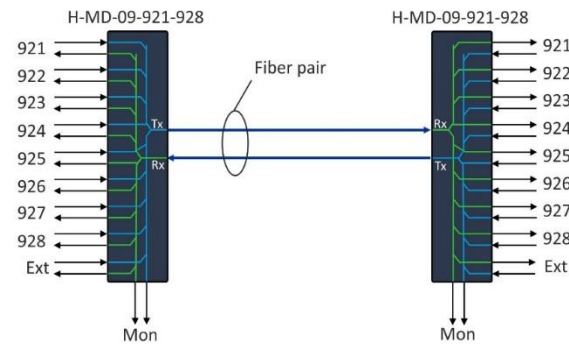

Figure 28: H-MD-09-921-928 in ptp-configuration

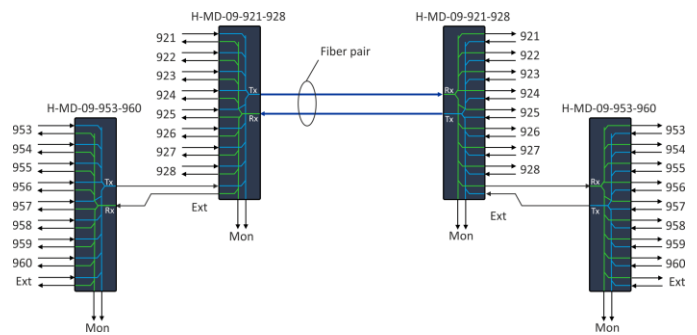

Figure 29: Example configuration

The table below compares selected parameters between the H-MD-C09-xxx-yyy and the low loss version H-MD-09-xxx-yyy-EM-LL. For technical data, see chapter 9.

PARAMETER	H-MD-C09-xxx-yyy	H-MD-09-xxx-yyy-EM-LL
Link loss, Ch Rx ⇒ Line Tx ⇒ Line Rx ⇒ Ch Tx	≤ 4.5dB	≤ 5.0dB
Link loss, Ext Rx ⇒ Line Tx ⇒ Line Rx ⇒ Ext Tx	≤ 7.0dB	≤ 1.9dB
Link loss, channel H-MD-C09-xxx-yyy via Ext ports	≤ 11.5dB	≤ 6.4dB
Link loss, channel H-MD-09-xxx-yyy-EM-LL via Ext ports	≤ 12.0dB	≤ 6.9dB
Ext port bandwidth, excl channel passband	1525.68-1564.68nm 191.6 to 196.5 THz	1504 -1580nm 189.7 to 199.33THz

Loss values at I-temp conditions.
Lower values apply at C-temp. See technical data in chapter 8.

The -LL filters use a more expensive filter design to provide a lower loss. Note that the low loss advantage of H-MD-09-xxx-yyy-EM-LL is on the Extension port loss. So H-MD-C09-xxx-yyy is a better choice for a 8ch configuration while the H-MD-C09-xxx-yyy-EM-LL steps in when additional filters are to be added via the Extension ports.

The figures below show the worst-case link losses for two 8+8ch example configurations.

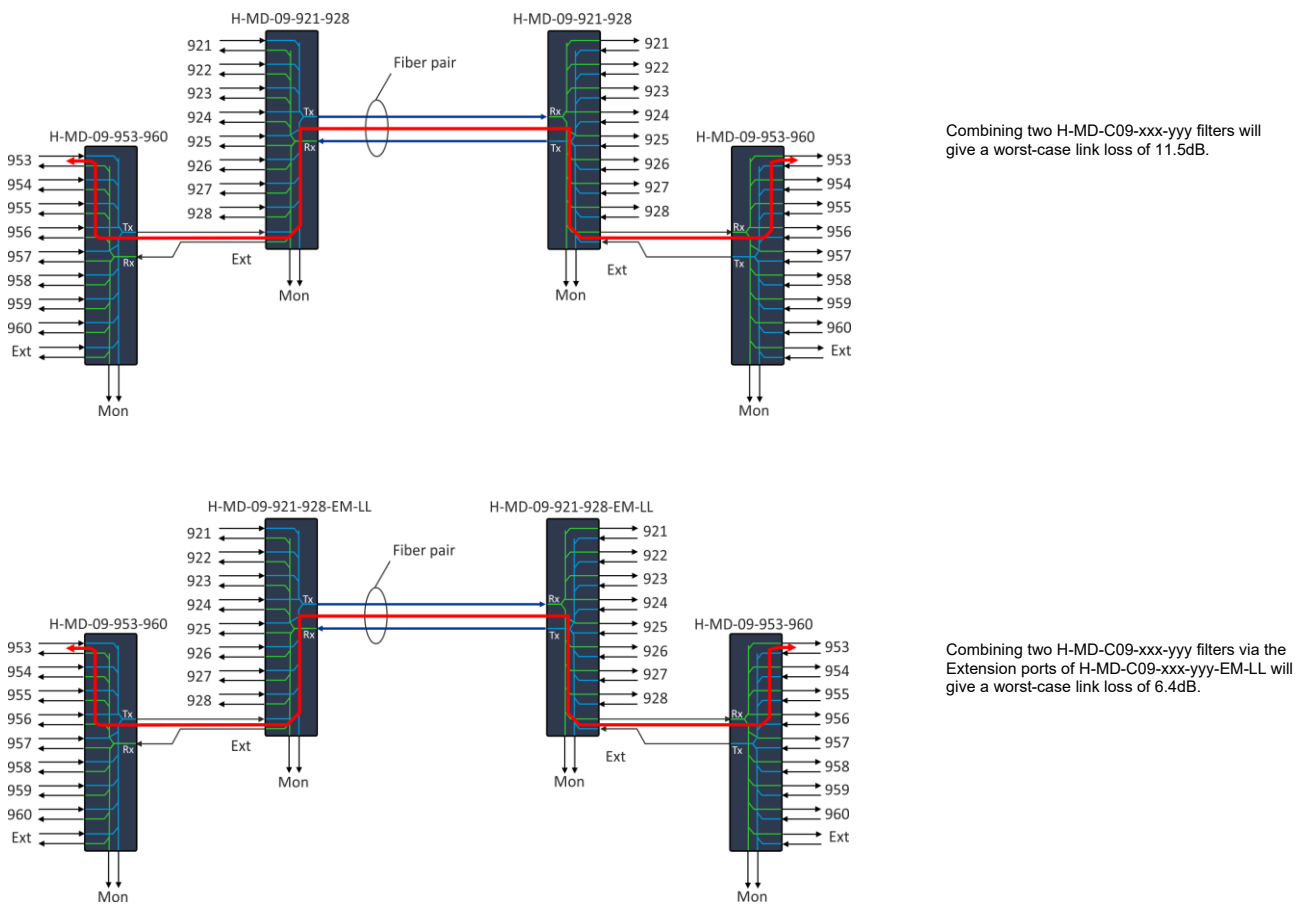
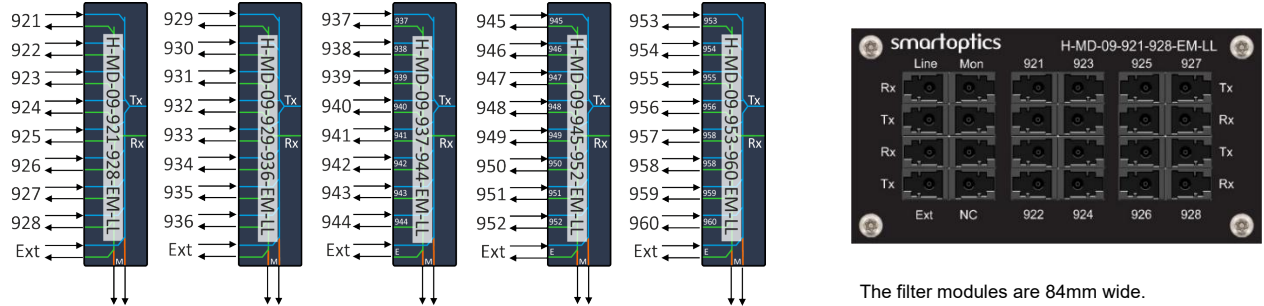

Figure 30: Configuration examples to show how the loss table above is used

4.5 H-MD-09-xxx-yyy-EM-LL; low loss 8ch DWDM filter

The H-MD-09-xxx-yyy-EM-LL are a set of 8ch DWDM filters covering the same channels as the H-MD-09-xxx-yyy filters, but uses a low loss filter design that provides a much lower loss through the Extension ports. The H-MD-09-xxx-yyy-EM-LL is thus advantageous when cascading multiple filters via the Extension ports.



The filter modules are 84mm wide.

Figure 31: H-MD-09-xxx-yyy-EM-LL logical icons and front plate example

The monitor ports tap off about 1% of the transmitted and received line signal. This provides the ability to monitor the channel power levels via a connected Optical Channel Monitoring (OCM) device or an optical spectrum analyzer.

The table below lists the provided variants:

ORDERING CODE	DWDM CHANNELS
H-MD-09-921-928-EM-LL	192.1 to 192.8 THz
H-MD-09-929-936-EM-LL	192.9 to 193.6 THz
H-MD-09-937-944-EM-LL	193.7 to 194.4 THz
H-MD-09-945-952-EM-LL	194.5 to 195.2 THz
H-MD-09-953-960-EM-LL	195.3 to 196.0 THz

The number of channels can be extended by connecting two or more filters via the Extension ports. The filters can be combined in any order i.e. need not be connected in consecutive channel order.

The figure below shows cascaded point-to-point configuration using two H-MD-09-xxx-yyy-EM-LL filters.

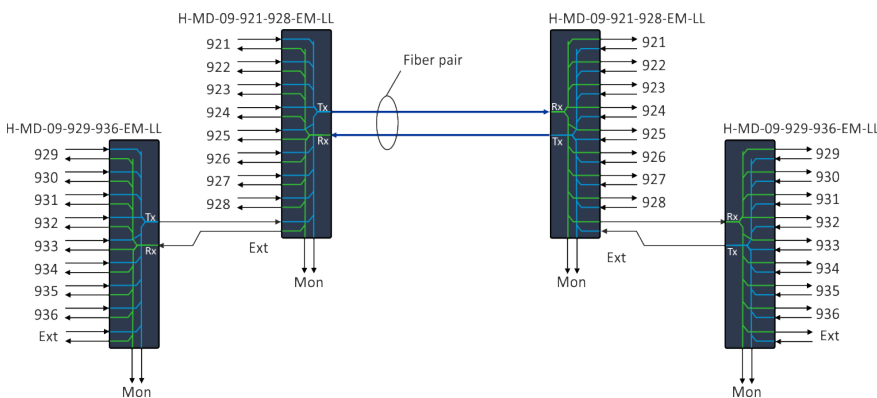

Figure 32: H-MD-09-921-928-EM-LL and H-MD-09-929-936-EM-LL in ptp-configuration

The table below compares selected parameters between the H-MD-C09-xxx-yyy and the low loss version H-MD-09-xxx-yyy-EM-LL. For technical data, see chapter 9.

PARAMETER	H-MD-C09-xxx-yyy	H-MD-09-xxx-yyy-EM-LL
Link loss, Ch Rx ⇒ Line Tx ⇒ Line Rx ⇒ Ch Tx	≤ 4.5dB	≤ 5.0dB
Link loss, Ext Rx ⇒ Line Tx ⇒ Line Rx ⇒ Ext Tx	≤ 7.0dB	≤ 1.9dB
Link loss, channel H-MD-C09-xxx-yyy via Ext ports	≤ 11.5dB	≤ 6.4dB
Link loss, channel H-MD-09-xxx-yyy-EM-LL via Ext ports	≤ 12.0dB	≤ 6.9dB
Ext port bandwidth, excl channel passband	1525.68-1564.68nm 191.6 to 196.5 THz	1504 -1580nm 189.7 to 199.33THz

Loss values at I-temp conditions.
Lower values apply at C-temp. See technical data in chapter 8.

The -LL filters use a more expensive filter design to provide a lower loss. Note that the low loss advantage of H-MD-09-xxx-yyy-EM-LL is on the Extension port loss. So H-MD-C09-xxx-yyy is a better choice for a 8ch configuration while the H-MD-C09-xxx-yyy-EM-LL steps in when additional filters are to be added via the Extension ports.

4.6 H-MD-09-xxx-yyy-4C; 400G 8ch DWDM filter

The H-MD-09-xxx-yyy-4C are a set of 8ch DWDM filters covering the same channels as the H-MD-09-xxx-yyy filters, but having a channel passband of 72.5GHz enabling 400Gbps/16QAM signals to be add/dropped. The pass-through (Ext ↔ Line) has an extra wide band coverage 1264 -1630nm which opens for a wide variety of combinations of LANWDM, CWDM, DWDM and OTDR solutions over the same infrastructure.

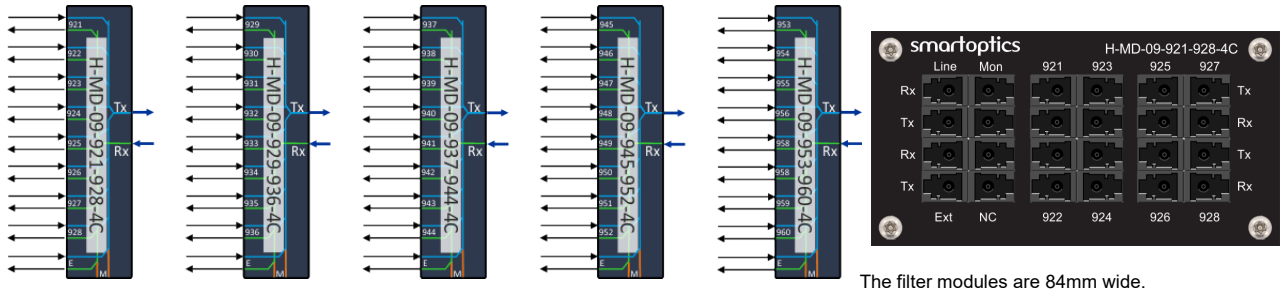

The filter modules are 84mm wide.

Figure 33: H-MD-09-xxx-yyy-4C logical icons and front plate example

The monitor ports tap off about 1% of the transmitted and received line signal. This provides the ability to monitor the channel power levels via a connected Optical Channel Monitoring (OCM) device or an optical spectrum analyzer.

The table below lists the provided variants:

ORDERING CODE	DWDM CHANNELS
H-MD-09-921-928-4C	192.1 to 192.8 THz
H-MD-09-929-936-4C	192.9 to 193.6 THz
H-MD-09-937-944-4C	193.7 to 194.4 THz
H-MD-09-945-952-4C	194.5 to 195.2 THz
H-MD-09-953-960-4C	195.3 to 196.0 THz

The number of channels can be extended by connecting two or more filters via the Extension ports. The filters can be combined in any order i.e. need not be connected in consecutive channel order.

The table below compares selected parameters between the H-MD-09-xxx-yyy-4C and the 100Gbps capable filters H-MD-C09-xxx-yyy and H-MD-09-xxx-yyy-EM-LL. For technical data, see chapter 9.

PARAMETER	H-MD-C09-xxx-yyy	H-MD-09-xxx-yyy-EM-LL	H-MD-09-xxx-yyy-4C
Link loss, Ch Rx ⇒ Line Tx ⇒ Line Rx ⇒ Ch Tx	≤ 4.5dB	≤ 5.0dB	≤ 5.2dB
Link loss, Ext Rx ⇒ Line Tx ⇒ Line Rx ⇒ Ext Tx	≤ 7.0dB	≤ 1.9dB	≤ 2.0dB
Link loss, (Ch Rx ⇒ Line Tx) ⇒ (Ext Rx ⇒ Line Tx) ⇒ Line Rx ⇒ Ext Tx) ⇒ (Line Rx ⇒ Ch Tx)	≤ 11.5dB	≤ 6.9dB	≤ 7.2dB
Ext port bandwidth, excl channel passband	1525.68-1564.68nm 191.6 to 196.5 THz	1504 -1580nm 189.7 to 199.33THz	1264 - 1630nm 183.92 to 237.7THz

The -4C filters have a wider channel and sharper passband which results in a higher add/drop loss.

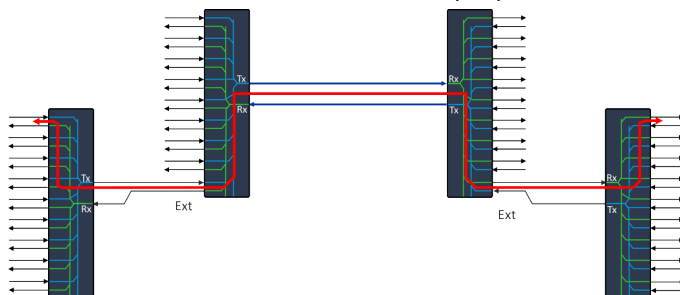

Note:
Loss values at I-temp conditions.
Lower values apply at C-temp. See technical data in chapter 8.

Link loss, (Ch Rx ⇒ Line Tx) ⇒ (Ext Rx ⇒ Line Tx ⇒ Line Rx ⇒ Ext Tx) ⇒ (Line Rx ⇒ Ch Tx)

4.7 H-MD-16-xxx-yyy; 16ch DWDM filter

The H-MD-16-xxx-yyy filters are two DWDM Mux/DeMux'es having 16 wavelength ports, one extension port and monitor ports for Tx and Rx line interfaces.

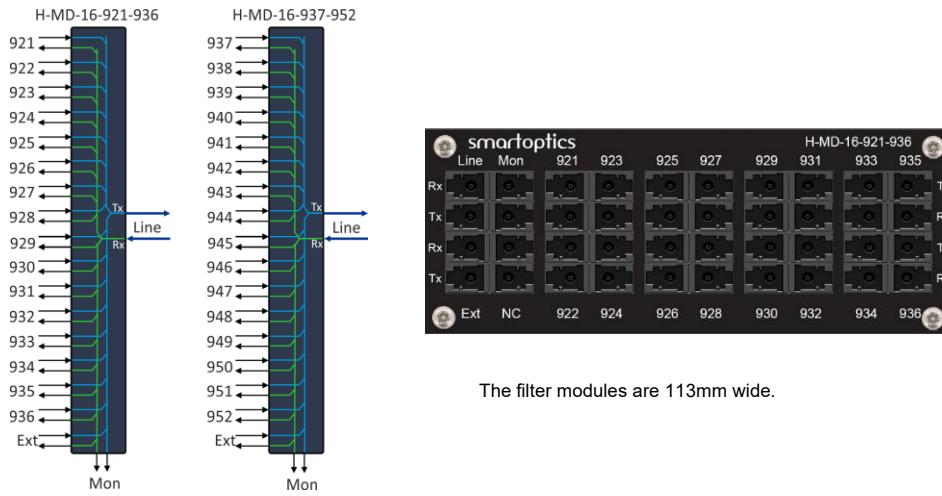

The filter modules are 113mm wide.

Figure 34: H-MD-16-xxx-yyy logical icons and front plate example

The monitor ports tap off about 1% of the transmitted and received line signal. This provides the ability to monitor the channel power levels via a connected Optical Channel Monitoring (OCM) device or an optical spectrum analyzer.

The table below lists the provided variants:

ORDERING CODE	DWDM CHANNELS
H-MD-16-921-936	192.1 to 193.6 THz
H-MD-16-937-952	193.7 to 195.2 THz

The two filters can be connected via the extension port to provide a 32ch configuration.

PARAMETER	H-MD-16-921-936	H-MD-16-937-952
Link loss, Ch Rx ⇒ Line Tx ⇒ Line Rx ⇒ Ch Tx	≤ 6.5dB	≤ 6.5dB
Link loss, Ext Rx ⇒ Line Tx ⇒ Line Rx ⇒ Ext Tx	≤ 9.6dB	≤ 9.6dB
Link loss, channel H-MD-16-937-952 via Ext ports	≤ 16.1dB	-
Link loss, channel H-MD-16-921-936 via Ext ports	-	≤ 16.1dB
Ext port bandwidth, excl channel passband	1520 -1580nm 189.7 - 197.2THz	1520 -1580nm 189.7 - 197.2THz

Loss values at I-temp conditions.

For additional technical data, see chapter 9.

4.8 H-MD-40-921-960; 40ch DWDM MuxDemux

The H-MD-40-921-960 filter is a 40-channel DWDM protocol transparent Mux/Demux unit in accordance with the ITU-T G.694.1 100GHz grid. The channels operate in the standard C-band in dual fiber working configuration.

The H-MD-40-921-960 has two Monitor ports that tap off 1% of the transmitted and received line signal. This provides the ability to monitor the channel power levels via a connected Optical Channel Monitoring (OCM) device or an optical spectrum analyzer.

The H-MD-40-921-960 is based on athermal AWG technology and is totally passive. This technology is restricted to -5 to +65°C operating temperature. H-MD-40-921-960 is a 19" rack mounted monolith having a height of 1RU.

For technical data, see chapter 9.



Figure 35: H-MD-40-921-960 icon and front plate

H-MD-40-921-960 has a wider channel passband allowing for 400Gbps 16QAM signals to pass.

PARAMETER	H-MD-40-921-960	
Link loss, Ch Rx ⇒ Line Tx ⇒ Line Rx ⇒ Ch Tx	≤ 11.8dB	Loss values at -5 to +65°C conditions.
Channel bandwidth (-3dB)	≥ 80GHz	

4.9 M-3840-LL; low-loss 40ch DWDM MuxDemux

The M-3840-LL filter is also a 40-channel DWDM protocol transparent Mux/Demux covering same channels as the above H-MD-40-921-960. The M-3840-LL is a low-loss alternative and is without any monitor ports to further reduce the losses. This filter is also not I-temp operational.

M-3840-LL is a 19" rack mounted monolith having a height of 1RU.



Figure 36: M-3840-LL icon and front plate

PARAMETER	M-3840-LL
Link loss, Ch Rx ⇒ Line Tx ⇒ Line Rx ⇒ Ch Tx	≤ 7.5dB

Loss values at C-temp conditions

See chapter 9 for additional technical data.

4.10 H-MD-48-914-961; 48ch DWDM MuxDemux

The H-MD-48-914-961 filter is a 48-channel DWDM protocol transparent Mux/Demux unit in accordance with the ITU-T G.694.1 100GHz grid. The channels operate in the standard C-band in dual fiber working configuration.

The H-MD-48-914-961 has two Monitor ports that tap off 1% of the transmitted and received line signal. This provides the ability to monitor the channel power levels via a connected Optical Channel Monitoring (OCM) device or an optical spectrum analyzer.

The H-MD-48-914-961 is based on athermal AWG technology and is totally passive. This technology is restricted to -5 to +65°C operating temperature. H-MD-48-914-961 is a 19" rack mounted monolith having a height of 1RU.

For technical data, see chapter 9.



Figure 37: H-MD-48-914-961 icon and front plate

H-MD-48-914-961 has a wider channel passband allowing for 400Gbps 16QAM signals to pass.

PARAMETER	H-MD-48-914-961	
Link loss, Ch Rx ⇒ Line Tx ⇒ Line Rx ⇒ Ch Tx	≤ 11.8dB	Loss values at -5 to +65°C conditions.
Channel bandwidth (-3dB)	≥ 80GHz	

4.11 H-OADM1x4-xxx-yyy; DWDM 1-way OADM filter

The H-OADM1x4-xxx-yyy is a one-sided 4ch DWDM add/drop filter. The filter has four add/drop ports, one Line interface, one Extension interface and two Monitor ports.

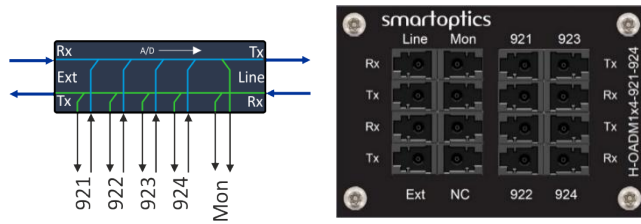

The filter modules are 65mm wide.

Figure 38: H-OADM1x4-921-924 icon and front plate

Channels outside the add/drop channel bands are glassed through the filter. The monitor ports (Mon) drop about 1% of the transmitted and received signal from the Line port.

The table below lists the provided variants:

ORDERING CODE	DWDM CHANNELS
H-OADM1x4-921-924	192.1 to 192.4 THz
H-OADM1x4-925-928	192.5 to 192.8 THz
H-OADM1x4-929-932	192.9 to 193.2 THz
H-OADM1x4-933-936	193.3 to 193.6 THz
H-OADM1x4-937-940	193.7 to 194.0 THz
H-OADM1x4-941-944	194.1 to 194.4 THz
H-OADM1x4-945-948	194.5 to 194.8 THz
H-OADM1x4-949-952	194.9 to 195.2 THz
H-OADM1x4-953-956	195.3 to 195.6 THz
H-OADM1x4-957-960	195.7 to 196.0 THz

Ten different versions of the filter are provided. They can be connected in pairs as shown in the figure below or towards a DWDM Mux/DeMux unit. Note that the Line port shall always face inwards a connection.

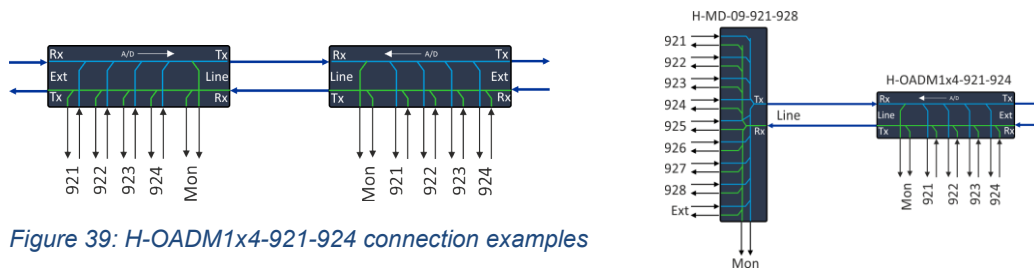

Figure 39: H-OADM1x4-921-924 connection examples

PARAMETER	H-OADM1X4-xxx-yyy
Link loss, Ch Rx ⇒ Line Tx ⇒ Line Rx ⇒ Ch Tx	≤ 3.5dB
Insertion loss, Ch Rx ⇒ Line Tx	≤ 2.5dB
Pass-through loss, Ext Rx ⇒ Line Tx	≤ 1.8dB
Passband Ext ⇔ Line	1500nm to 1600nm

Loss values at I-temp conditions.
Lower values apply at C-temp. See technical data in chapter 8.

See chapter 9 for additional technical data.

4.12 H-OADM2x4-xxx-yyy; DWDM 2-way OADM filter

The H-OADM2x4-xxx-yyy is a two-sided 4ch DWDM add/drop filter. The filter has four add/drop ports, one group for east and one for west direction.

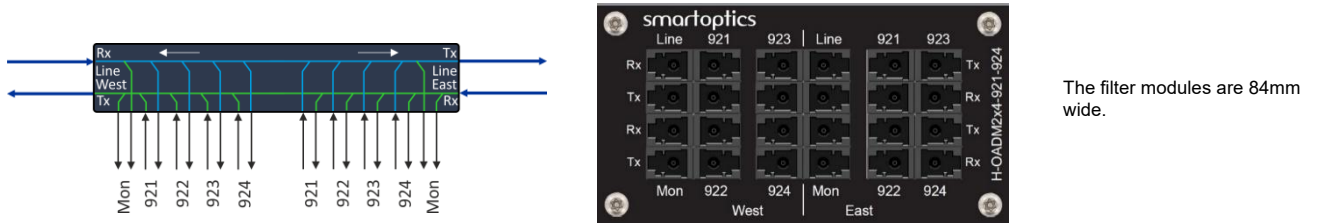

Figure 40: H-OADM2x4-921-924 icon and front plate

Channels outside the add/drop channel bands are glassed through the filter. There are two monitor ports (Mon) that drop about 1% of the transmitted and received signal from the Line ports.

The table below lists the provided variants:

ORDERING CODE	DWDM CHANNELS
H-OADM2x4-921-924	192.1 to 192.4 THz
H-OADM2x4-925-928	192.5 to 192.8 THz
H-OADM2x4-929-932	192.9 to 193.2 THz
H-OADM2x4-933-936	193.3 to 193.6 THz
H-OADM2x4-937-940	193.7 to 194.0 THz
H-OADM2x4-941-944	194.1 to 194.4 THz
H-OADM2x4-945-948	194.5 to 194.8 THz
H-OADM2x4-949-952	194.9 to 195.2 THz
H-OADM2x4-953-956	195.3 to 195.6 THz
H-OADM2x4-957-960	195.7 to 196.0 THz

Ten different versions of the filter are provided. They can be connected in pairs as shown in the figure below or towards a DWDM Mux/DeMux unit.

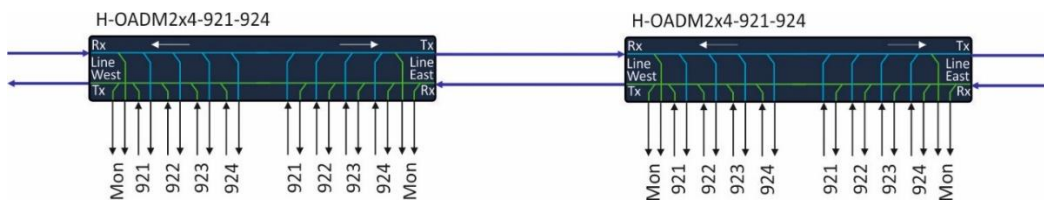

Figure 41: Two H-OADM2x4-921-924 filters connected in a bus configuration.

PARAMETER	H-OADM2X4-xxx-yyy
Link loss, Ch Rx ⇒ Line Tx ⇒ Line Rx ⇒ Ch Tx	≤ 3.5dB
Insertion loss, Ch Rx ⇒ Line Tx	≤ 2.5dB
Pass-through loss, Ext Rx ⇒ Line Tx	≤ 3.2dB
Passband Ext ⇔ Line	1500nm to 1600nm

Loss values at I-temp conditions.
Lower values apply at C-temp. See technical data in chapter 8.

See chapter 9 for additional technical data.

4.13 H-OADM1x4-xxx-yyy-4C; DWDM 1-way OADM filter

The H-OADM1x4-xxx-yyy-4C is a one-sided 4ch DWDM add/drop filter. The filter has four add/drop ports, one Line interface, one Extension interface and two Monitor ports.

The H-OADM1x4-xxx-yyy-4C filters are part of a series of filters where the channel passband is wide enough to allow 400G 16QAM signals to be add/dropped by the filter. These filters are:

- H-MD-09-xxx-yyy-4C
- H-OADM1x4-xxx-yyy-4C
- H-OADM2x4-xxx-yyy-4C
- H-OADM1x2-xxx-yyy-4C
- H-OADM2x2-xxx-yyy-4C
- H-MD-40-921-960
- H-MD-48-914-961

These 400G capable filters can of course be combined with the other 100G capable filters, but then the support for 400G signals is lost.

Channels outside the add/drop channel bands of the H-OADM1x4-xxx-yyy-4C filters are glassed through the filter. This intrinsic pass-through bandwidth is from 1264 -1630nm which opens for a wide variety of combinations of LANWDM, CWDM, DWDM and OTDR solutions over the same infrastructure.

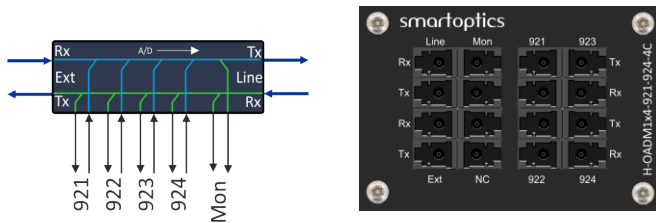

The filter modules are 65mm wide.

Figure 42: H-OADM1x4-921-924-4C icon and front plate

The monitor ports (Mon) drop about 1% of the transmitted and received signal from the Line port.

The table below lists the provided variants:

ORDERING CODE	DWDM CHANNELS
H-OADM1x4-921-924-4C	192.1 to 192.4 THz
H-OADM1x4-925-928-4C	192.5 to 192.8 THz
H-OADM1x4-929-932-4C	192.9 to 193.2 THz
H-OADM1x4-933-936-4C	193.3 to 193.6 THz
H-OADM1x4-937-940-4C	193.7 to 194.0 THz
H-OADM1x4-941-944-4C	194.1 to 194.4 THz
H-OADM1x4-945-948-4C	194.5 to 194.8 THz
H-OADM1x4-949-952-4C	194.9 to 195.2 THz
H-OADM1x4-953-956-4C	195.3 to 195.6 THz
H-OADM1x4-957-960-4C	195.7 to 196.0 THz

Ten different versions of the filter are provided. They can be connected in pairs as shown in the figure below or towards a DWDM Mux/DeMux unit. Note that the Line port shall always face inwards a connection.

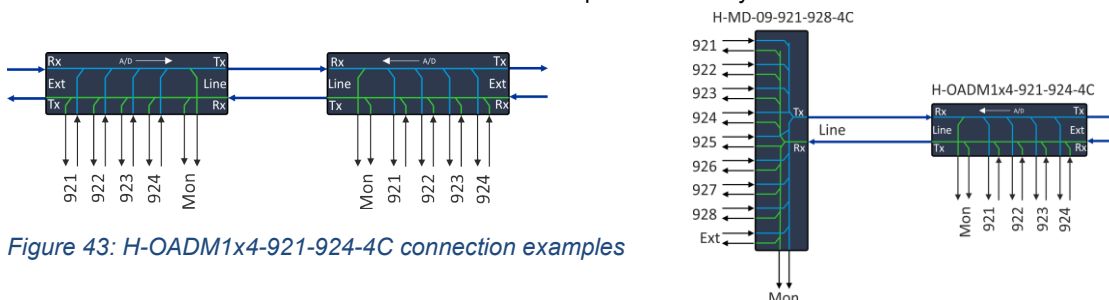

Figure 43: H-OADM1x4-921-924-4C connection examples

PARAMETER	H-OADM1X4-xxx-yyy-4C
Link loss, Ch Rx ⇒ Line Tx ⇒ Line Rx ⇒ Ch Tx	≤ 4.0dB
Insertion loss, Ch Rx ⇒ Line Tx	≤ 2.5dB
Pass-through loss, Ext Rx ⇒ Line Tx	≤ 1.0dB
Passband Ext ⇔ Line	1264nm to 1630nm

Loss values at I-temp conditions.
Lower values apply at C-temp. See technical data in chapter 8.

See chapter 9 for additional technical data.

4.14 H-OADM2x4-xxx-yyy-4C; DWDM 2-way OADM filter

The H-OADM2x4-xxx-yyy-4C is a two-sided 4ch DWDM add/drop filter. The filter has four add/drop ports, one group for east and one for west direction.

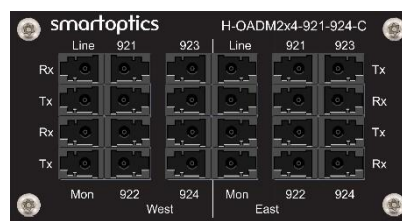
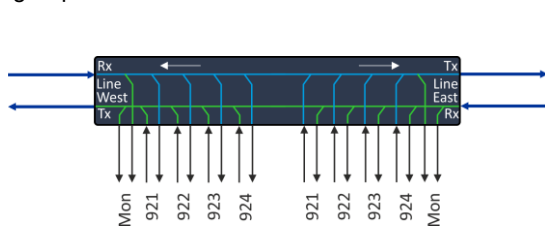

The filter modules are 84mm wide.

Figure 44: H-OADM2x4-921-924-4C icon and front plate

The H-OADM2x4-xxx-yyy-4C filters are part of a series of filters where the channel passband is wide enough to allow 400G 16QAM signals to be add/dropped by the filter. These filters are:

- H-MD-09-xxx-yyy-4C
- H-OADM1x4-xxx-yyy-4C
- H-OADM2x4-xxx-yyy-4C
- H-OADM1x2-xxx-yyy-4C
- H-OADM2x2-xxx-yyy-4C
- H-MD-40-921-960
- H-MD-48-914-961

These 400G capable filters can of course be combined with the other 100G capable filters, but then the support for 400G signals is lost.

Channels outside the add/drop channel bands of the H-OADM2x4-xxx-yyy-4C filters are glassed through the filter. This intrinsic pass-through bandwidth is from 1264 -1630nm which opens for a wide variety of combinations of LANWDM, CWDM, DWDM and OTDR solutions over the same infrastructure.

Channels outside the add/drop channel bands are glassed through the filter. There are two monitor ports (Mon) that drop about 1% of the transmitted and received signal from the Line ports.

The table below lists the provided variants:

ORDERING CODE	DWDM CHANNELS
H-OADM2x4-921-924-4C	192.1 to 192.4 THz
H-OADM2x4-925-928-4C	192.5 to 192.8 THz
H-OADM2x4-929-932-4C	192.9 to 193.2 THz
H-OADM2x4-933-936-4C	193.3 to 193.6 THz
H-OADM2x4-937-940-4C	193.7 to 194.0 THz
H-OADM2x4-941-944-4C	194.1 to 194.4 THz
H-OADM2x4-945-948-4C	194.5 to 194.8 THz
H-OADM2x4-949-952-4C	194.9 to 195.2 THz
H-OADM2x4-953-956-4C	195.3 to 195.6 THz
H-OADM2x4-957-960-4C	195.7 to 196.0 THz

Ten different versions of the filter are provided. They can be connected in pairs as shown in the figure below or towards a DWDM Mux/DeMux unit.

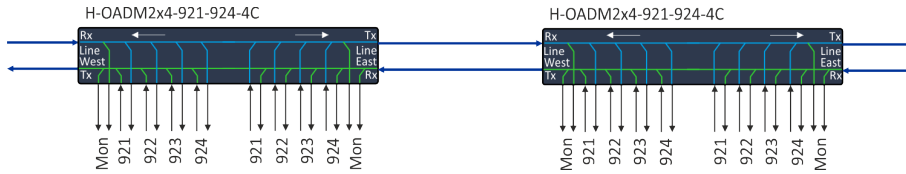

Figure 45: Two H-OADM2x4-921-924-4C filters connected in a bus configuration.

PARAMETER	H-OADM2X4-xxx-yyy-4C
Link loss, Ch Rx ⇒ Line Tx ⇒ Line Rx ⇒ Ch Tx	≤ 4.5dB
Insertion loss, Ch Rx ⇒ Line Tx	≤ 2.8dB
Pass-through loss, Line Rx ⇒ Line Tx	≤ 2.0dB
Passband Line West ⇔ Line East	≤ 2.6dB between 1375-1405nm 1264nm to 1630nm

Loss values at I-temp conditions.
Lower values apply at C-temp. See technical data in chapter 8.

See chapter 9 for additional technical data.

4.15 H-OADM1x2-xxx-yyy-4C; DWDM 2ch 1-way OADM filter

The H-OADM1x2-xxx-yyy-4C is a one-sided 2ch DWDM add/drop filter.



The filter modules are 55mm wide.

Figure 46: H-OADM1x2-921-922-4C icon and front plate

The H-OADM1x2-xxx-yyy-4C filters are part of a series of filters where the channel passband is wide enough to allow 400G 16QAM signals to be add/dropped by the filter. These filters are:

- H-MD-09-xxx-yyy-4C
- H-OADM1x4-xxx-yyy-4C
- H-OADM2x4-xxx-yyy-4C
- H-OADM1x2-xxx-yyy-4C
- H-OADM2x2-xxx-yyy-4C
- H-MD-40-921-960
- H-MD-48-914-961

These 400G capable filters can of course be combined with the other 100G capable filters, but then the support for 400G signals is lost.

Channels outside the add/drop channel bands of the H-OADM1x2-xxx-yyy-4C filters are glassed through the filter. Note that this intrinsic pass-through bandwidth is from 1460 -1630nm, i.e. more narrow than the other filters in the 400G capable filter family.

Channels outside the add/drop channel bands are glassed through the filter. There are two monitor ports (Mon) that drop about 1% of the transmitted and received signal from the Line ports.

The table below lists the provided variants:

ORDERING CODE	DWDM CHANNELS	ORDERING CODE	DWDM CHANNELS
H-OADM1x2-921-922-4C	192.1 + 192.2 THz	H-OADM1x2-941-942-4C	194.1 + 194.2 THz
H-OADM1x2-923-924-4C	192.3 + 192.4 THz	H-OADM1x2-943-944-4C	194.3 + 194.4 THz
H-OADM1x2-925-926-4C	192.5 + 192.6 THz	H-OADM1x2-945-946-4C	194.5 + 194.6 THz
H-OADM1x2-927-928-4C	192.7 + 192.8 THz	H-OADM1x2-947-948-4C	194.7 + 194.8 THz
H-OADM1x2-929-930-4C	192.9 + 193.0 THz	H-OADM1x2-949-950-4C	194.9 + 195.0 THz
H-OADM1x2-931-932-4C	193.1 + 193.2 THz	H-OADM1x2-951-952-4C	195.1 + 195.2 THz
H-OADM1x2-933-934-4C	193.3 + 193.4 THz	H-OADM1x2-953-954-4C	195.3 + 195.4 THz
H-OADM1x2-935-936-4C	193.5 + 193.6 THz	H-OADM1x2-955-956-4C	195.5 + 195.6 THz
H-OADM1x2-937-938-4C	193.7 + 193.8 THz	H-OADM1x2-957-958-4C	195.7 + 195.8 THz
H-OADM1x2-939-940-4C	193.9 + 194.0 THz	H-OADM1x2-959-960-4C	195.9 + 196.0 THz

PARAMETER	H-OADM2x2-xxx-yyy-4C
Link loss, Ch Rx ⇒ Line Tx ⇒ Line Rx ⇒ Ch Tx	≤ 2.0dB
Insertion loss, Ch Rx ⇒ Line Tx	≤ 1.1dB
Insertion loss, Ext Rx ⇒ Line Tx	≤ 1.0dB
Passband Line West ⇔ Line East	1500 -1600nm

See chapter 9 for additional technical data.

4.16 H-OADM2x2-xxx-yyy-4C; DWDM 2-way OADM filter

The H-OADM2x2-xxx-yyy-4C is a two-sided 2ch DWDM add/drop filter. The filter has four add/drop ports, one group for east and one for west direction.

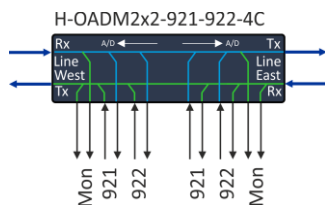

The filter modules are 65mm wide.

Figure 47: H-OADM2x2-921-924-4C icon and front plate

The H-OADM2x2-xxx-yyy-4C filters are part of a series of filters where the channel passband is wide enough to allow 400G 16QAM signals to be add/dropped by the filter. These filters are:

- H-MD-09-xxx-yyy-4C
- H-OADM1x4-xxx-yyy-4C
- H-OADM2x4-xxx-yyy-4C
- H-OADM1x2-xxx-yyy-4C
- H-OADM2x2-xxx-yyy-4C
- H-MD-40-921-960

These 400G capable filters can of course be combined with the other 100G capable filters, but then the support for 400G signals is lost.

Channels outside the add/drop channel bands of the H-OADM2x2-xxx-yyy-4C filters are glassed through the filter. Note that this intrinsic pass-through bandwidth is from 1460 -1630nm, i.e. more narrow than the other filters in the 400G capable filter family.

Channels outside the add/drop channel bands are glassed through the filter. There are two monitor ports (Mon) that drop about 1% of the transmitted and received signal from the Line ports.

The table below lists the provided variants:

ORDERING CODE	DWDM CHANNELS
H-OADM-2x2-921-922-4C	192.1 + 192.2 THz
H-OADM2x2-923-924-4C	192.3 + 192.4 THz
H-OADM2x2-925-926-4C	192.5 + 192.6 THz
H-OADM2x2-927-928-4C	192.7 + 192.8 THz
H-OADM2x2-929-930-4C	192.9 + 193.0 THz
H-OADM2x2-931-932-4C	193.1 + 193.2 THz
H-OADM2x2-933-934-4C	193.3 + 193.4 THz
H-OADM2x2-935-936-4C	193.5 + 193.6 THz
H-OADM2x2-937-938-4C	193.7 + 193.8 THz
H-OADM2x2-939-940-4C	193.9 + 194.0 THz

Note that the filters cover 20 out of the 40 channels. This is an initial restriction to limit the number of filter variants.

PARAMETER	H-OADM2X2-xxx-yyy-4C
Link loss, Ch Rx ⇒ Line Tx ⇒ Line Rx ⇒ Ch Tx	≤ 2.6dB
Insertion loss, Ch Rx ⇒ Line Tx	≤ 1.4dB
Pass-through loss, Line West ⇒ Line East	≤ 2.4dB
Passband Line West ⇔ Line East	1460 -1630nm

Loss values at I-temp conditions.

Lower values apply at C-temp. See technical data in chapter 8.

See chapter 9 for additional technical data.

4.17 H-MD-BP1x5; DWDM Band split/combine filter

The H-MD-BP1x5 is a band split/combine filter with a line port and 5 channel band ports. The 40 DWDM channels are split into five groups of 8 channels enabling fan-out configurations.

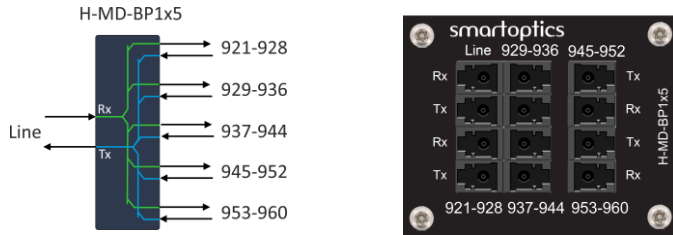

The filter module is 55mm wide.

Figure 48: H-MD-BP1x5 icon and front plate

The channels of the sub ports match the channels of the H-MD-09-xxx-yyy and H-MD-09-xxx-yyy-EM-LL DWDM Mux/Demux filters.

PARAMETER	H-MD-BP1X5
Insertion loss, Line ⇒ Ch band Tx	≤ 2.5dB

Loss values at I-temp conditions.
Lower values apply at C-temp. See technical data in chapter 8.

See chapter 9 for additional technical data.

The figure below shows a network example where one branch is using two 4ch AD-filters to enable 4ch drops at two different locations. The other branches use 8ch Mux/Demux filters to terminate all 8 channels.

The example includes optical amplifiers at the head-end to extend the distance. The Smartoptics DCP-F-R22 provides both amplification and automatic power balancing in a 1 RU rack mount.

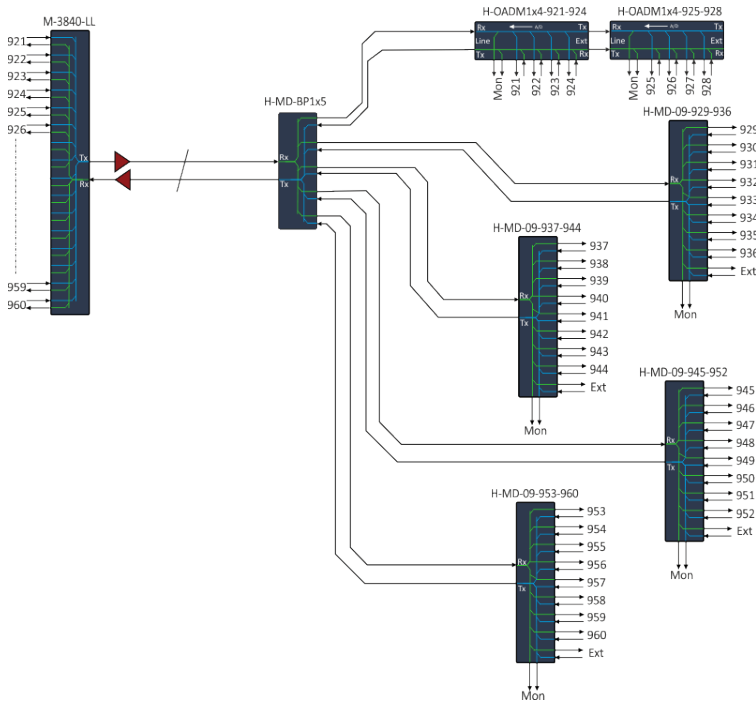

Head-end with a 40ch DWDM filter and 2x DCP-F units.

Figure 49: Example configuration

4.18 H-MD-BP1x10; DWDM Band split/combine filter

The H-MD-BP1x10 is a band split/combine filter with a line port and 10 channel band ports.

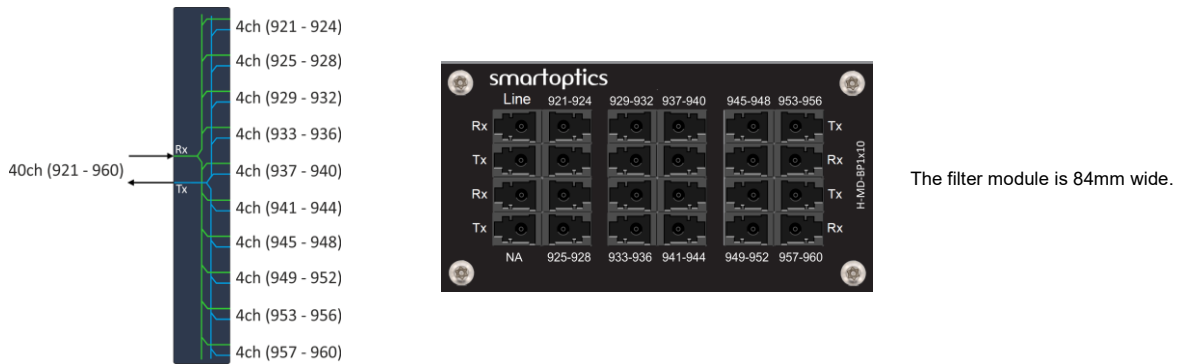

Figure 50: H-MD-BP1x10 icon and front plate

PARAMETER	H-MD-BP1X10
Insertion loss, Line ⇒ Ch band Tx	≤ 3.2dB

Loss values at I-temp conditions.

Lower values apply at C-temp. See technical data in chapter 8.

The 40 DWDM channels are split into ten groups of 4 channels enabling fan-out configurations as shown in the figure. The channels can be added/dropped via the 8ch H-MD-09-xxx-yyy or H-MD-09-xxx-yyy-EM-LL DWDM Mux/Demux filters or via the 4ch H-OADM1x4-xxx-yyy OADM filters as shown in the figure below.

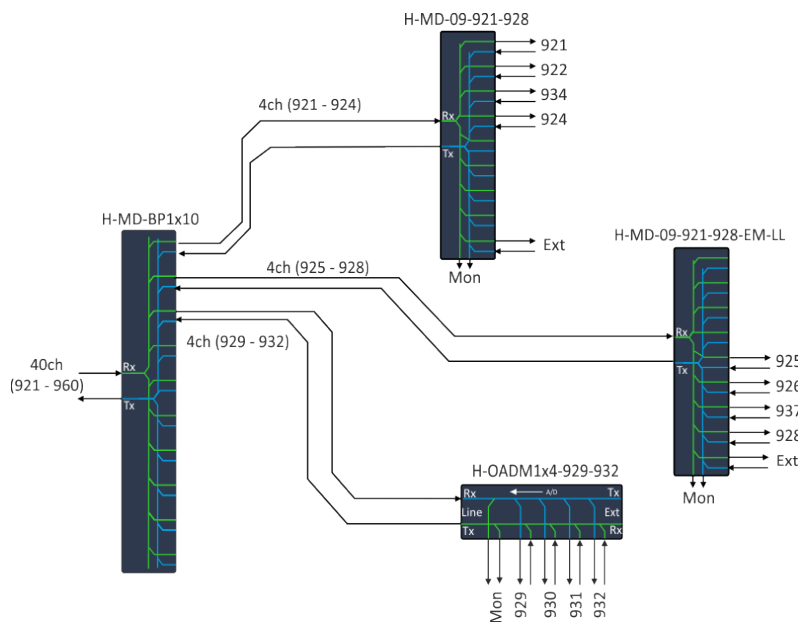

Figure 51: 10-way fan-out configuration.

Note that if the 8ch DWDM Mux/Demux units are used, only four channels are extracted per filter. So same filter is used on two locations. A more port-effective solution is to use the 4ch OADM filters.

4.19 H-CIRC-3P; DWDM Optical Circulator

The H-CIRC-3P is an optical circulator that allows light to travel through in only one direction. A wavelength entering port A will only propagate to port COM. A signal entering port COM will only propagate to port B.

The typical application is to enable single-fiber operation using the filters intended for fiber-pair configurations. Due to reflections in connectors and splices, one must use different channels in up- and down-link to avoid interference.



Figure 52: 3-port circulator icon and front plate

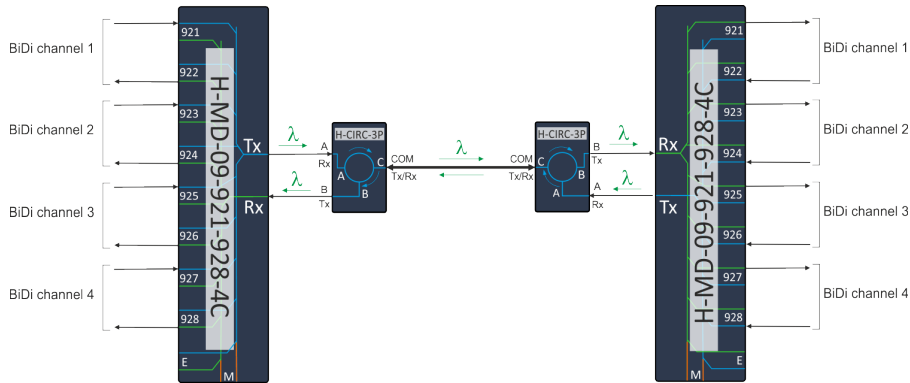
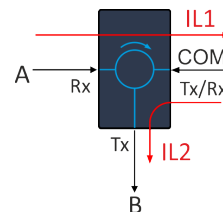

Figure 53: Single-fiber configuration example

PARAMETER	H-CIRC-3P
Operating wavelength range λ_1	1530nm to 1570nm (190.95THz – 195.95THz) ¹⁾
Operating wavelength range λ_2	1490nm to 1530nm (195.95THz – 201.20THz)
Insertion loss A Rx \Rightarrow COM Tx/Rx (IL1) for wavelength range λ_1	≤ 1.1 dB
Insertion loss COM Tx/Rx \Rightarrow B Tx (IL2) for wavelength range λ_1	≤ 1.1 dB
Insertion loss A Rx \Rightarrow COM Tx/Rx (IL1) for wavelength range λ_2	≤ 1.4 dB
Insertion loss COM Tx/Rx \Rightarrow B Tx (IL2) for wavelength range λ_2	≤ 1.4 dB

Loss values at I-temp conditions.
Lower values apply at C-temp. See technical data in chapter 8.

¹⁾ Typical 40ch DWDM channel plan is from 192.10THz to 196.00THz



4.20 H-MD-04-921-928-SFx & H-MD-04-929-936-SFx

The H-MD-04-921-928-SFx and H-MD-04-929-936-SFx filters are two sets of 4 channel DWDM-filters for single-fiber configurations. There are eight DWDM wavelengths used to create and the 4 bi-directional channels, one wavelength in uplink and another in downlink, providing 4 bi-directional channels in total. Consequently, there are two different filters, denoted “A” and “B” where the difference lies in the transmitted and received channels.

The channel band of the Extension port is (1460 -1630nm) to enable e.g. OTDR signals to pass through the filters.

A Monitor port that taps off 1% of the transmitted and received line signal provides the ability to monitor the channel power levels via a connected Optical Channel Monitoring (OCM) device or an optical spectrum analyzer.

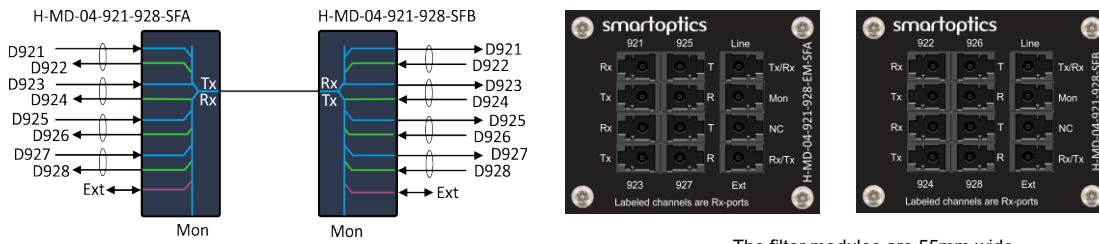

The filter modules are 55mm wide.

Figure 54: H-MD-04-921-928-SFx icons and front plates

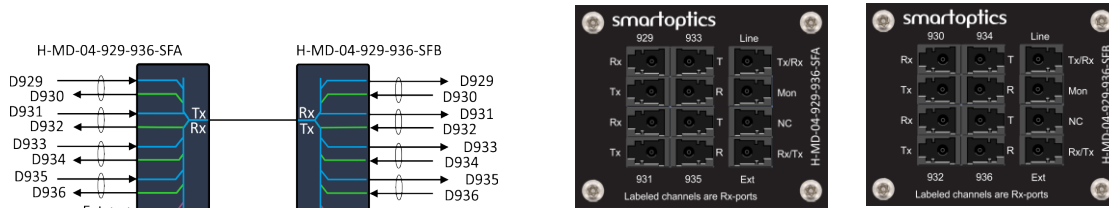

The filter modules are 55mm wide.

Figure 55: H-MD-04-929-936-SFx icons and front plates

The filters have an Extension port enabling the two pairs to be combined into an 8ch bi-directional configuration.

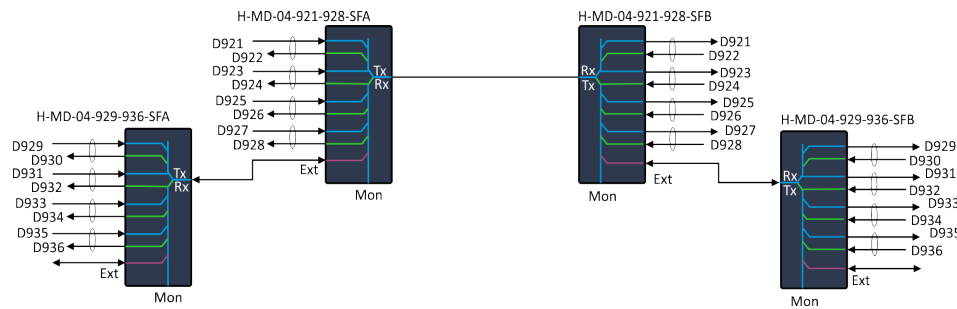

Figure 56: 8ch configuration

ORDERING CODE	LANWDM CHANNELS
H-MD-04-921-928-SFA	4ch DWDM SF Mux/Demux, Extension & Monitor ports 921-928 A
H-MD-04-921-928-SFB	4ch DWDM SF Mux/Demux, Extension & Monitor ports 921-928 B
H-MD-04-929-936-SFA	4ch DWDM SF Mux/Demux, Extension & Monitor ports 929-936 A
H-MD-04-929-936-SFB	4ch DWDM SF Mux/Demux, Extension & Monitor ports 929-936 B

PARAMETER	H-MD-4LAN-EM-SFx
Passband Ext-port	1264 -1630nm / 183.9 to 237.2THz
Link loss, per channel (A)	≤ 5.0dB
Link loss, Extension (B)	≤ 2.0dB

Loss values at I-temp conditions.

Lower values apply at C-temp. See technical data in chapter 8.

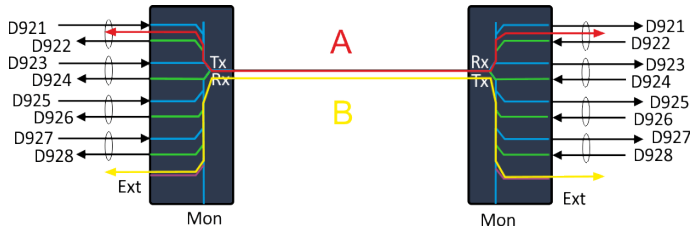

5 LANWDM filters

5.1 H-MD-4LAN-EM-SFx; LANWDM Mux/Demux filters

In 5G networks there is a need to transport multiple 25G Ethernet services. A first choice would be using DWDM technology which would give a high channel count, but the chromatic dispersion will limit the bridgeable distance to about 10km. Dispersion compensation and amplifiers will typically be required, which will drive up the cost and complexity.

The option is to use LANWDM channels that operate in the 1300nm region where the dispersion properties are the lowest for standard single-mode fiber. As an example, this enables longer distances up to 30km for 25G Ethernet services without need for amplifiers or dispersion compensation.

The H-MD-4LAN-EM-SFx filters are two LANWDM-filters for single-fiber configurations.

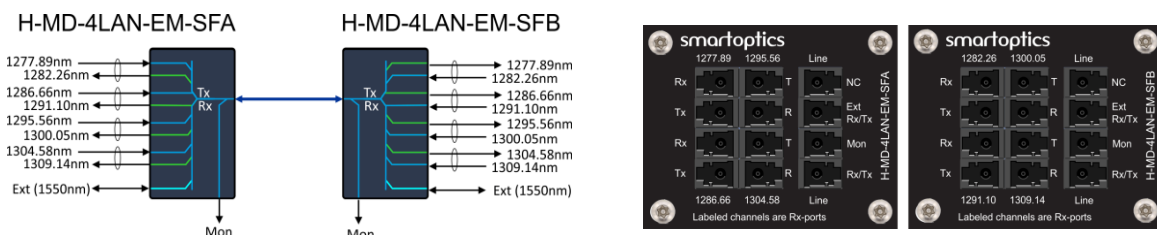

Figure 57: H-MD-4LAN-EM-SFx icons and front plates

The filter modules are 55mm wide.

ORDERING CODE	LANWDM CHANNELS
H-MD-4LAN-EM-SFA	1277.89nm 1286.66nm 1295.56nm 1304.58nm
H-MD-4LAN-EM-SFB	1282.26nm 1291.10nm 1300.05nm 1309.14nm

There are eight LANWDM channels defined and the H-MD-4LAN-EM-SFx filters are using one channel in uplink and another in downlink, providing 4 bi-directional channels in total. Consequently, there are two different filters, denoted "A" and "B" where the difference lies in the transmitted and received channels.

The H-MD-4LAN-EM-SFx filters have an Extension port intended for single-fiber DWDM filters. In 5G networks there is typically a need to transport e.g. 10G Ethernet services together with 25G Ethernet services. This Extension port covers the complete C-band which provides a flexible addition of any DWDM channel combination.

The H-MD-4LAN-EM-SFx filters have a Monitor port that tap off 1% of the transmitted and received line signal. This provides the ability to monitor the channel power levels via a connected Optical Channel Monitoring (OCM) device or an optical spectrum analyzer.

PARAMETER	H-MD-4LAN-EM-SFx
Passband Ext-port	1528.66 to 1561.53nm / 192.0 to 196.10THz
Insertion loss, Channel (A)	≤ 3.5dB
Insertion loss, Ext (C)	≤ 1.4dB
Link loss, Channel ((B)	≤ 4.9dB
Link loss, Ext (D)	≤ 2.8dB

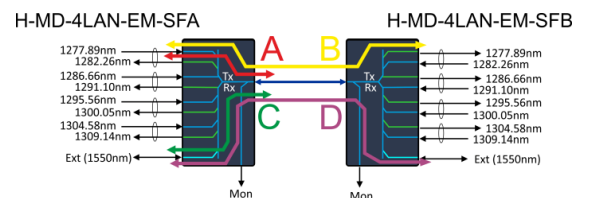

Loss values at I-temp conditions.

Lower values apply at C-temp. See technical data in chapter 8.

5.2 H-MD-4LAN-295-309

The H-MD-4LAN-295-309 filter is a LANWDM Mux/Demux covering four of the LANWDM wavelengths 1295.56nm, 1300.05nm, 1304.58nm and 1309.14nm. These wavelengths are also part of the CW-WDM MSA, covering O-BAND DWDM technology spaced with 200GHz. Thus, the filter can as an example be used with LANWDM transceivers or as a 4x100G configuration using single lambda 100G O-BAND DWDM transceivers shown in the figure below.

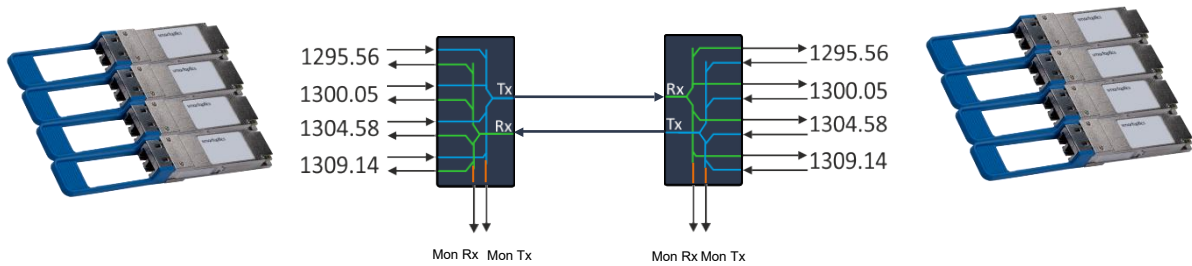

Figure 59: 4x100G configuration using 100G O-band DWDM transceivers

PARAMETER	H-MD-4LAN-295-309
Transmitted channels	1295.56nm, 1300.05nm, 1304.58nm, 1309.14nm
Insertion loss, per LANWDM channel	Max 1.7 dB @ C-temp
Link loss, per LANWDM channel	Max 3.0dB @ C-temp
PART NUMBER	DESCRIPTION
H-MD-4LAN-295-309	H-Series: 4ch LANWDM Mux/Demux + Mon-ports, 1295.56/1300.05/1304.58/1309.14nm, 55mm, Link-loss =3.5dB, LC/UPC

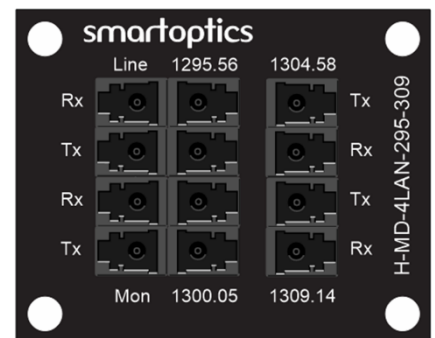

Figure 58: Front view of H-4LAN-295-309

6 O-Band DWDM Filters

6.1 H-MD-8OWDM-284-289

The H-MD-8OWDM-284-298 is a 8ch O-Band DWDM Mux/DeMux. The eight wavelength ports of the H-MD-8OWDM-284-289 covers eight O-Band DWDM channels spaced with 200Ghz; 228.4, 228.6, 228.8, 229.0, 229.2, 229.4, 229.6, 229.8THz.

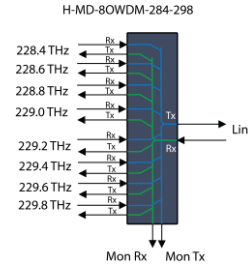
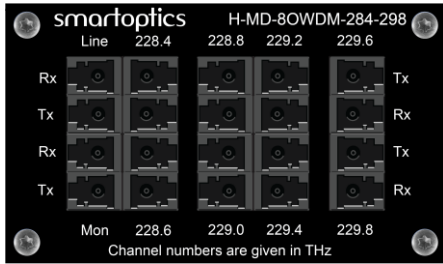

Figure 60: H-MD-8OWDM-284-298 icon and front plate

The filter is intended to operate with the 100GbE O-Band QSFP28 transceivers: TQ2026-OxxC-SO. Covering the 8 channels in the table below:

TRANSCEIVER PN	FREQUENCY [THZ]	FILTER CHANNEL NUMBER
TQ2026-O55C-SO	228.4	284
TQ2026-O53C-SO	228.6	286
TQ2026-O51C-SO	228.8	288
TQ2026-O49C-SO	229.0	290
TQ2026-O47C-SO	229.2	292
TQ2026-O45C-SO	229.4	294
TQ2026-O43C-SO	229.6	296
TQ2026-O41C-SO	229.8	298

6.2 H-MD-16OWDM-284-314

The H-MD-8OWDM-284-298 is a 16ch O-Band DWDM Mux/DeMux. The ports of the H-MD-8OWDM-284-289 covers sixteen O-Band DWDM channels spaced with 200GHz; 228.4, 228.6, 228.8, 229.0, 229.2, 229.4, 229.6, 229.8, 230.0, 230.2, 230.4, 230.6 230.8, 231.0, 231.2 and 231.4THz.

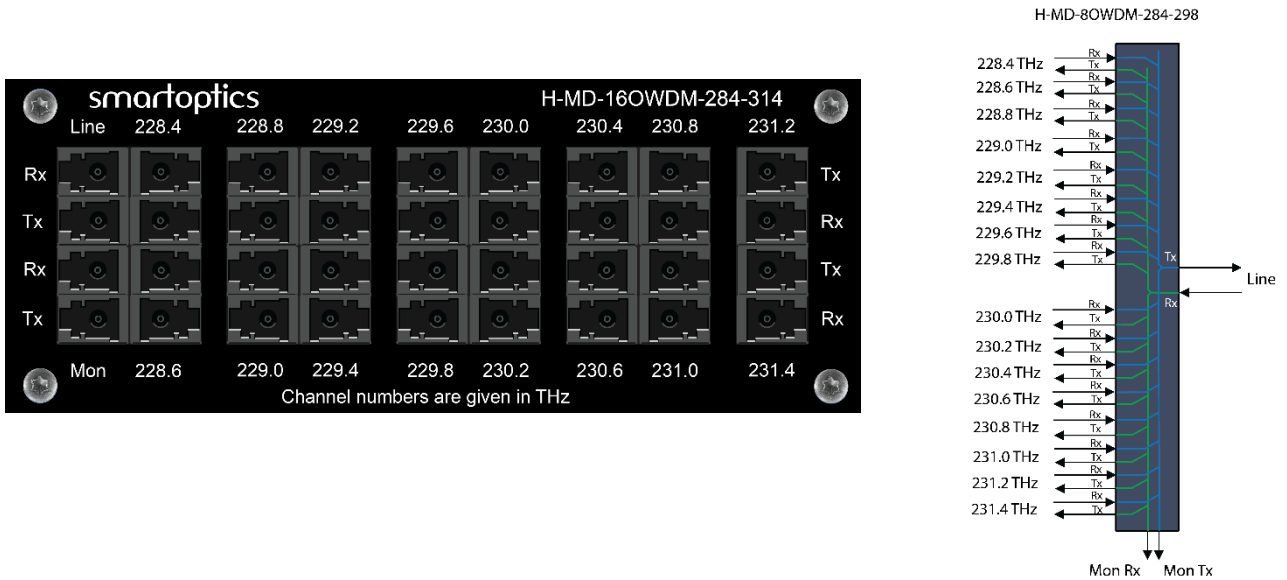

Figure 61: H-MD-16OWDM-384-314 icon and front plate

The filter is intended to operate with the 100GbE O-Band QSFP28 transceivers: TQ2026-OxxC-SO. Covering the 16 channels in the table below:

TRANSCEIVER PN	FREQUENCY [THZ]	FILTER CHANNEL NUMBER
TQ2026-O55C-SO	228.4	284
TQ2026-O53C-SO	228.6	286
TQ2026-O51C-SO	228.8	288
TQ2026-O49C-SO	229.0	290
TQ2026-O47C-SO	229.2	292
TQ2026-O45C-SO	229.4	294
TQ2026-O43C-SO	229.6	296
TQ2026-O41C-SO	229.8	298
TQ2026-O39C-SO	230.0	300
TQ2026-O37C-SO	230.2	302
TQ2026-O35C-SO	230.4	304
TQ2026-O33C-SO	230.6	306
TQ2026-O31C-SO	230.8	308
TQ2026-O29C-SO	231.0	310
TQ2026-O27C-SO	231.2	312
TQ2026-O25C-SO	231.4	314

7 Special application filters

7.1 H-MD-3155; 1310 / 1550 band Mux/Demux

The H-MD-3155 is a 1310/1550nm band Mux/Demux unit. The H-MD-3155 band filter is intended for cases where a legacy 1310nm channel is to be combined with CWDM channels in the upper CWDM-band (1460nm - 1630nm) or DWDM channels.

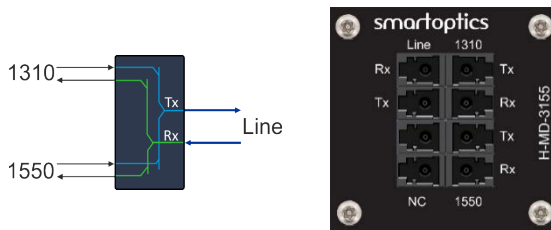

The filter module is 45mm wide.

Figure 62: H-MD-3155 icon and front plate

PARAMETER	H-MD-3155
Operating wavelength range 1310 port	1264.5nm to 1350nm
Operating wavelength range 1550 port	1460nm to 1630nm
Link loss 1310 ↔ 1310 (A)	≤ 1.9dB
Link loss 1550 ↔ 1550 (B)	≤ 1.2dB
Insertion loss 1310/1550 ↔ Line (C)	≤ 1.4dB

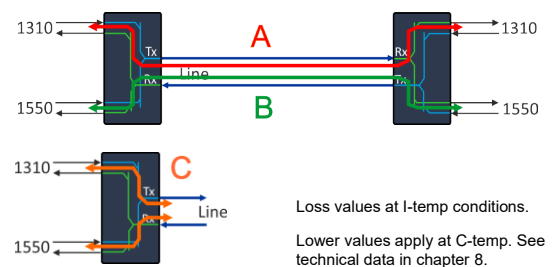

Loss values at I-temp conditions.
Lower values apply at C-temp. See technical data in chapter 8.

The figure shows an example configuration with the H-MD-C09H-E-LL filter. For technical data, see chapter 7

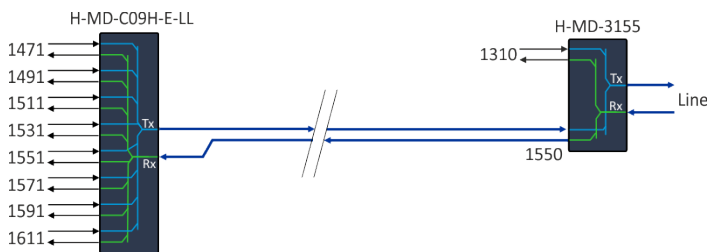

Figure 63: Mixed 1310nm legacy and CWDM configuration example

The 1310nm port covers 1265.5-1350nm which also includes the low band CWDM channels 1271-1331nm. This port can thus be used for e.g. 100G CWDM4-MSA channels, enabling a 100G channel to be carried as an alternative via this port. The figure below shows such example configuration and the occupied space in the mounting brackets for one side. The distance is limited by power budget of the 100G-LR transceivers to about 6km.

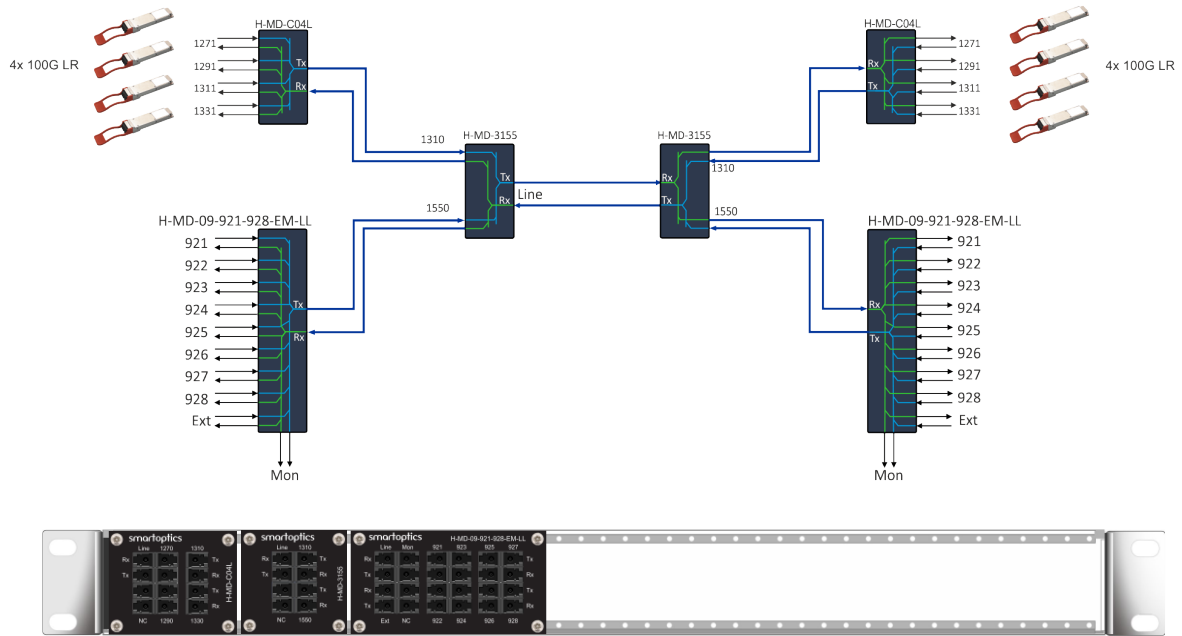

Figure 64: Mixed 4x 100G and DWDM configuration example

To extend the distance, a 100G-ZR4 transceiver can be connected to the 1310nm port.

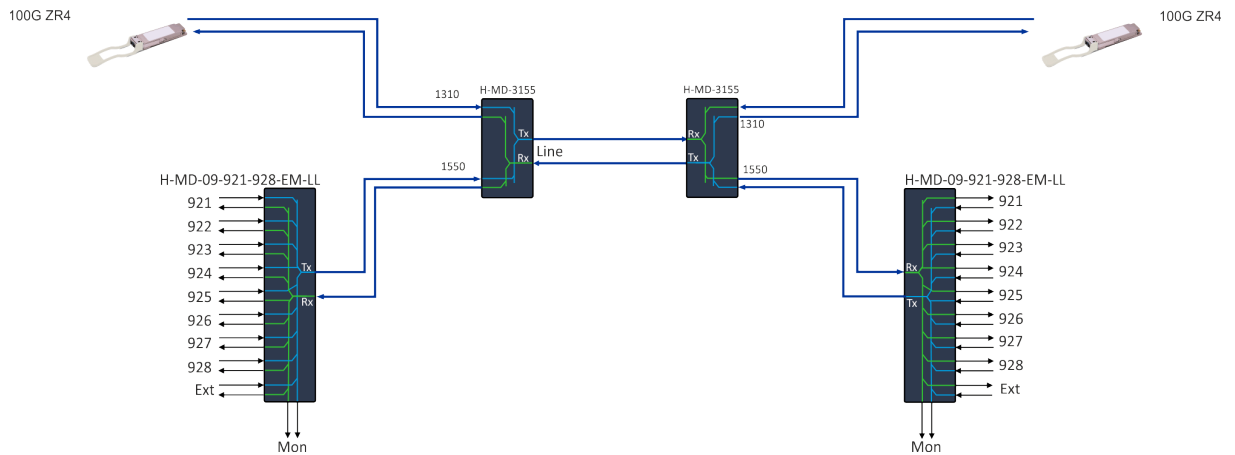

Figure 65: Mixed 1x 100G and DWDM configuration example

7.2 H-MD-3155-HI; 1310/1550 Mux/Demux, Hi Isolation

The H-MD-3155-HI is a 1310/1550nm band Mux/Demux unit with high isolation between the 1550 and 1310 band. The H-MD-3155 band filter is intended for cases where a legacy 1310nm channel is to be combined with CWDM channels in the upper CWDM-band (1460nm - 1630nm) or DWDM channels, both amplified and unamplified.

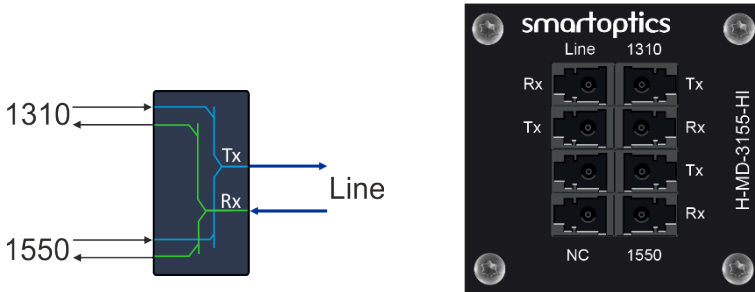

Figure 66: H-MD-3155 icon and front plate

PARAMETER	H-MD-3155-HI
Operating wavelength range 1310 port	1264.5nm to 1350nm
Operating wavelength range 1550 port	1460nm to 1630nm
Link loss 1310 ⇄ 1310 (A)	≤ 2.4dB
Link loss 1550 ⇄ 1550 (B)	≤ 2.4dB
Insertion loss 1310/1550 ⇄ Line (C)	≤ 1.2dB

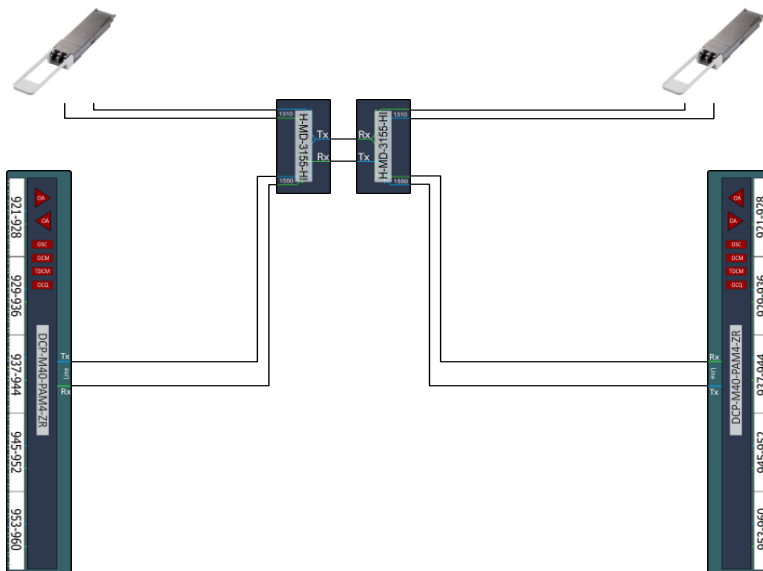
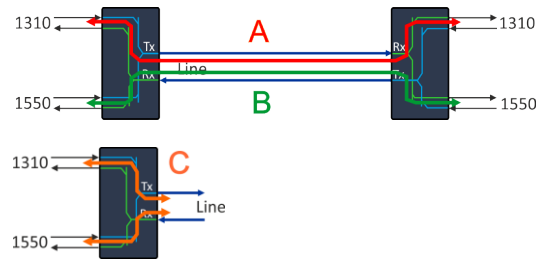

Figure 67: Mixed 1x 100G and Amplified DWDM configuration example

7.3 H-SB-XC-6MPO (Shuffle Box with 6 MPO-12)

The H-SB-XC-6MPO is a module in H-series format that can cross-connects up to six (6) different MPO-12 sources. The H-SB-XC-6MPO is connected with the DCP-R through a single-mode MPO-12 type B, female, trunk cable.

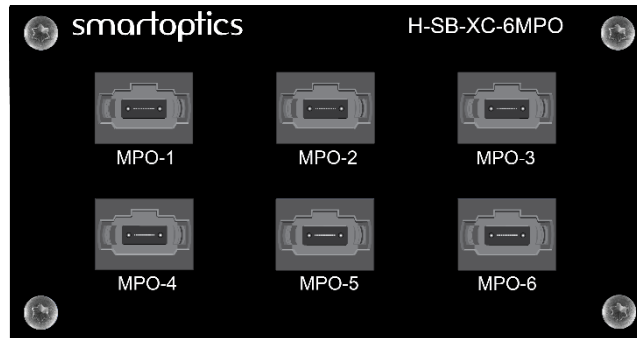

Figure 68: Front of H-SB-XC-6MPO

The primary application for the H-SB-XC-6MPO is for cross-connecting up to 6 different degrees in Smartoptics ROADMs (Reconfigurable Optical Add/Drop Multiplexer) products DCP-R within one node. The illustration below shows how four DCP-R-9D-CS are cross-connected using four MPO-12 type B, female cables and the Shuffle Box.

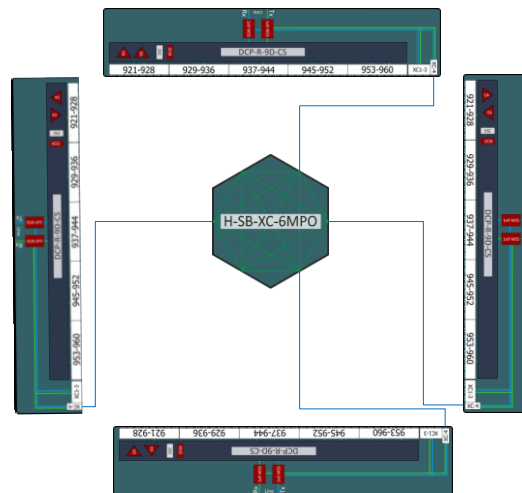

Figure 69: Illustration of how four DCP-R-9D-CS are interconnected through the H-SB-XC-6MPO

PARAMETER	H-SB-XC-6MPO
Operating band	DWDM
Insertion loss	Max 0.7dB
Connector type	MPO12 (SM, type B, female, APC)
ORDERING CODE	DESCRIPTION
H-SB-XC-6MPO	H-Series: 6 degrees shufflebox, 84mm, MPO12 Type-B

7.4 H-BO-1xMPO-10xLC (Break-out Box 1xMPO-10xLC)

The H-BO-XC-6MPO is a module in H-series format that breaks out an MPO-12 connection to ten LC connectors, or five duplex LC connections.

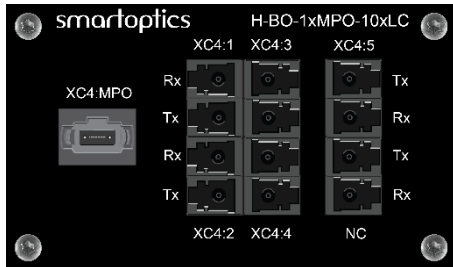

Figure 70: Front of H-BO-1xMPO-10xLC



Figure 71: Logical Icon of H-BO-1xMPO-1xLC

The primary application for the H-BO-1xMPO-10xLC is to break out the MPO connection XC4 on the Smartoptics ROADM (Reconfigurable Optical Add/Drop Multiplexer) product DCP-R-9D-CS to five duplex fiber connections. This is illustrated in the image below.

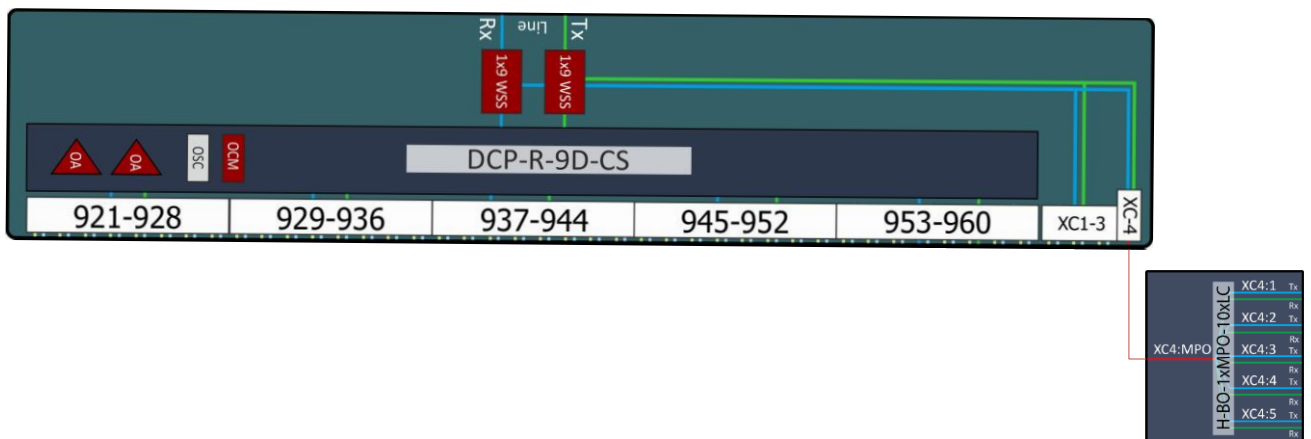

Figure 72: Illustration of breaking out the XC-4 MPO connector on the DCP-R9D-CS into five duplex LC ports

PARAMETER	H-SB-XC-6MPO
Operating band	DWDM
Insertion loss, MPO	Max 0.7dB
Insertion loss, LC	Max 0.3 dB
Connector type	SM LC (UPC) & MPO12 (SM, type B, female, APC)
OERDERING CODE	DESCRIPTION
H-SB-XC-6MPO	H-Series: 6 degrees shufflebox, 84mm, MPO12 Type-B

7.5 H-BO-SM-1xMPO-8xLC

The H-BO-SM-1xMPO-8xLC is a module in H-series format that breaks out an MPO-12 connection to four duplex LC connections over single-mode fibers.

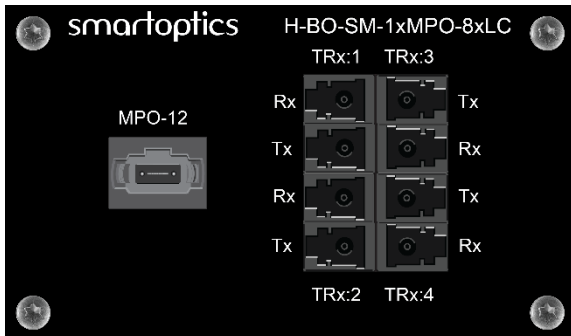

Figure 73: Front of H-BO-SM-1xMPO-8xLC

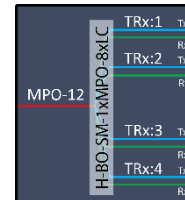

Figure 74: Logical icon of H-BO-SM-1xMPO-8xLC

The primary application for the H-BO-SM-1xMPO-8xLC is to break out an MPO-12 connector interface of a Single-mode transceiver with eight fibers, to four duplex LC connections. Breaking out the MPO-12 connector enables an easy aggregation of four asynchronous streams, for instance QSFP28 LR4 to SFP28 LR.

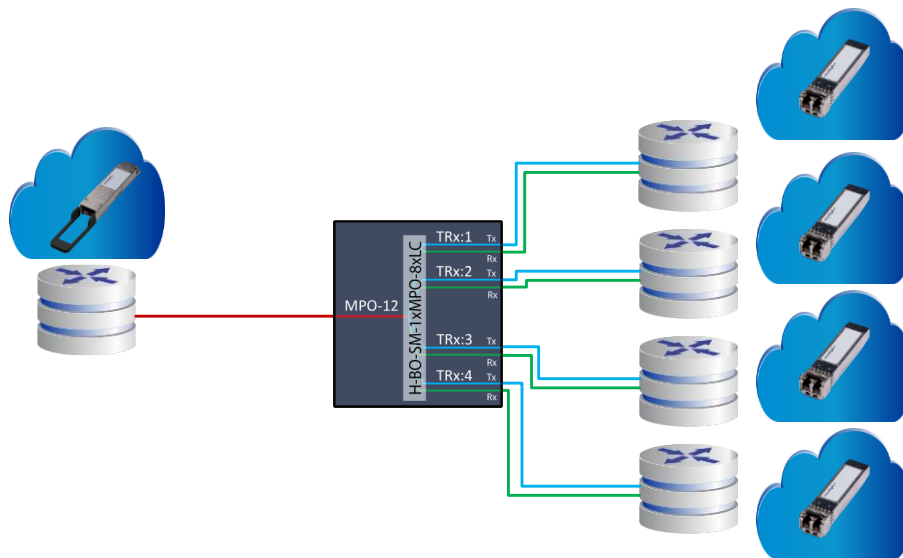

Figure 75: Illustrative application of H-BO-SM-1xMPO-8xLC

PARAMETER	CONDITIONS
Operating band	1310, 1550nm
Insertion loss, MPO-12 <-> LC	Max 0.7 dB
Operating temperature	-40°C to +85 °C
Connector type	MPO-12 (SM, type B, female, APC) LC (SM, UPC)

7.6 H-BO-MM-1xMPO-8xLC

The H-BO-MM-1xMPO-8xLC is a module in H-series format that breaks out an MPO-12 connection to four duplex LC connections over multi-mode fibers.

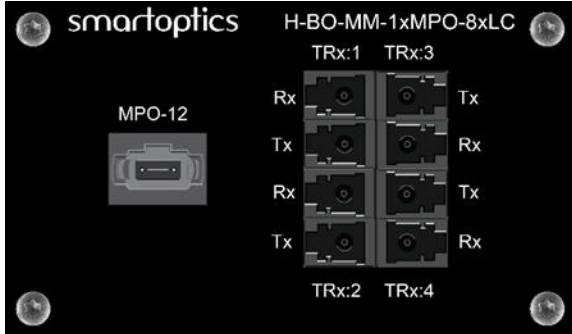

Figure 76: Front of H-BO-MM-1xMPO-8xLC



Figure 77: Logical icon of H-BO-MM-1xMPO-8xLC

The primary application for the H-BO-MM-1xMPO-8xLC is to break out an MPO-12 connector interface of a Single-mode transceiver with eight fibers, to four duplex LC connections. Breaking out the MPO-12 connector enables an easy aggregation of four asynchronous streams, for instance QSFP28 SR4 to SFP28 SR.

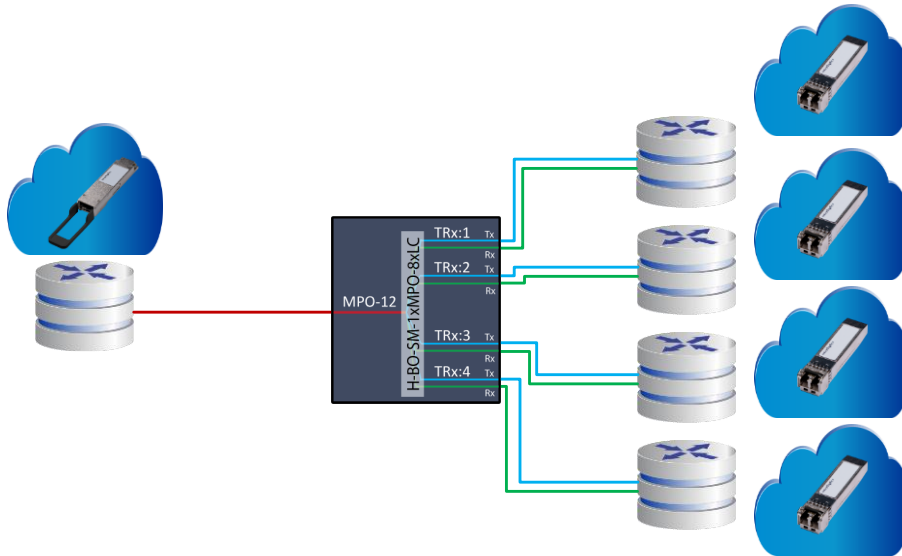

Figure 78: Illustrative application of H-BO-MM-1xMPO-8xLC

PARAMETER	CONDITIONS
Operating band	850nm
Insertion loss, MPO-12 <-> LC	Max 0.7 dB
Operating temperature	-40°C to +85 °C
Connector type	MPO-12 (MM, type B, female, UPC) LC (MM, UPC)

7.7 H-D1X4

The H-D1x4 is a dual 1x4 splitter/combiner unit. An optical signal entering the Tx/Rx line port will be split evenly at the four splitter ports. The primary application is together with the Smartoptics ROADMs products, see below for the functional overview to see how to use the filter to achieve a CDC (colorless, directionless, contentionless) solution up to four degrees.

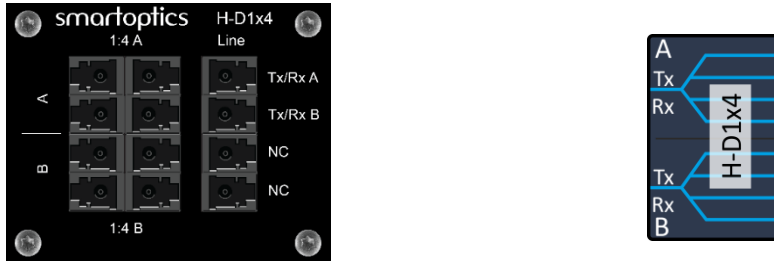

Figure 79: Front and logical icon of H-D1x4

The dual 1:4 Splitter/Combiner enables transponders/wavelengths to be connected into WSS ports (colorless) and up to four ROADMs line degrees (directionless), while avoiding wavelength interference (contentionless), all without requiring manual fiber changes or manual intervention.

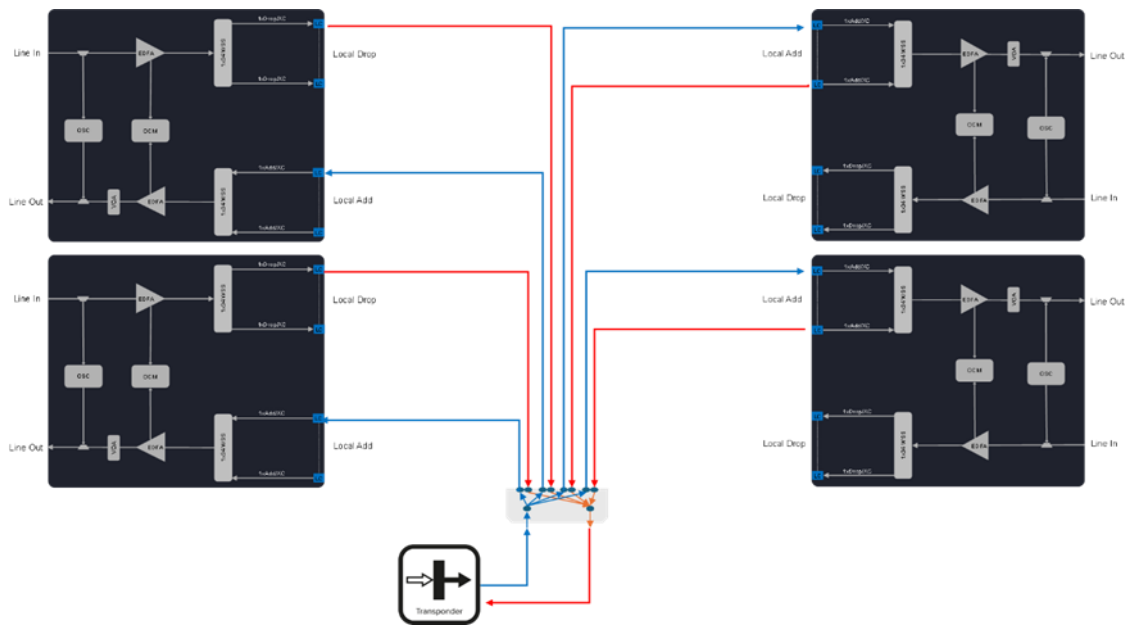

Figure 80: Functional Diagram of the H-D1x4 with a DCP-R

7.8 H-D4X4

The H-D1x4 is a dual 4x4 splitter/combiner unit. The filter consists of two sides A and B. Each side allows spitting or combining of four signals. The primary application of this splitter/combiner filter is together with the Smartoptics ROADM products, see below to see for a functional overview of the filter.

Functionality:

- A signal entering one A-side Rx port (A:x) is split into all four Tx ports on the B-side (B:x).
- A signal entering one B-side Rx port (B:x) is split into all four Tx ports on the A-side (A:x).



Figure 81: Front and logical icon of H-D4x4

The Dual 4:4 Splitter/Combiner enables 4 different transponders/wavelengths to be connected into WSS ports (colorless) and up to four ROADM line degrees (directionless), The 4 transponders/wavelengths cannot use the same channels (4 channel contention) but will avoid interference with all other wavelength (contentionless), all without requiring manual fiber changes or manual intervention.

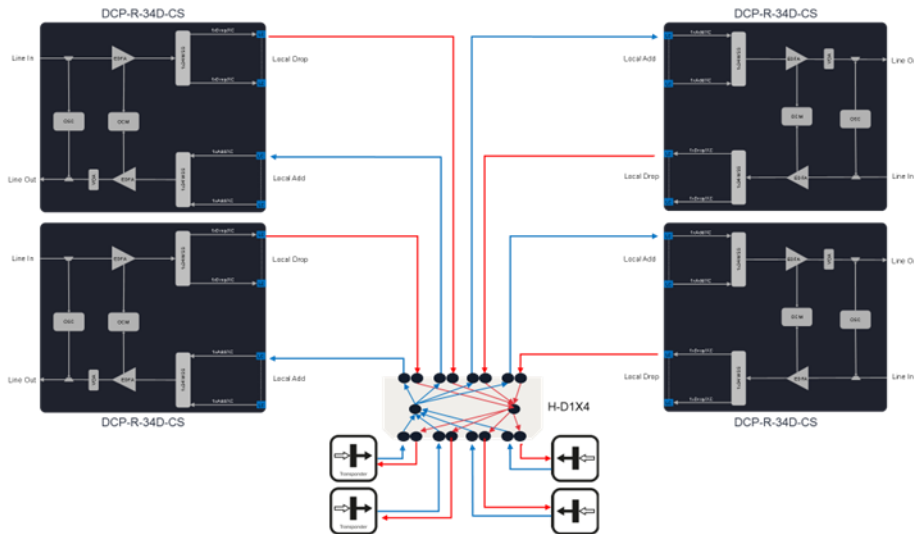

8 Chassis

8.1 H-CHASSI-1RU

The different modules are mounted in a 1RU chassis for 19" rack mount. The mounting area is 422mm wide and can be used for a wide variety of filter module combinations.

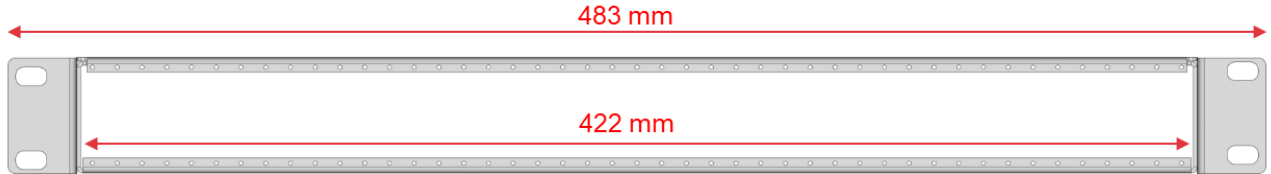

Figure 82: H-CHASSI-1RU

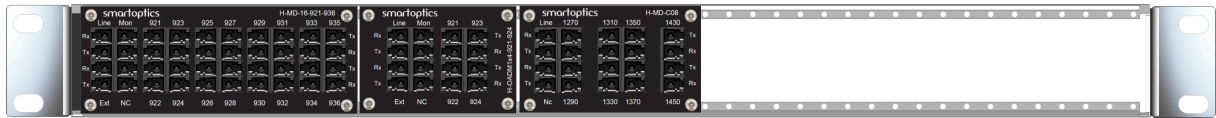

Figure 83: Example configuration with 3x filter modules

The figure above shows an example configuration having three modules occupying 253mm.

The mounting brackets can be re-located to support recessed, mid or flushed mounting in the rack.

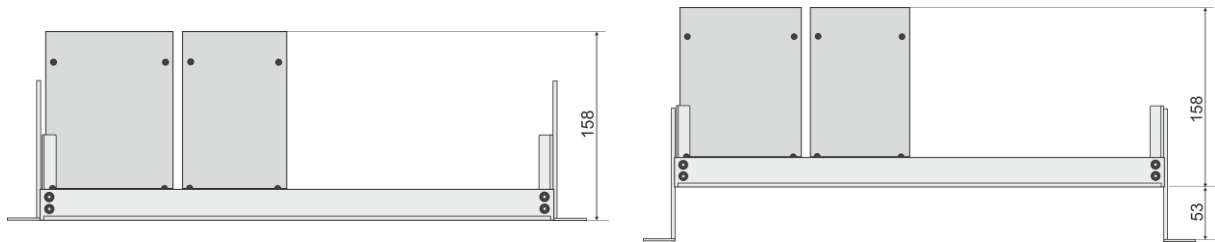

Figure 84: Mounting bracket positions

Table 1: Technical data

PARAMETER	VALUE
Rack mount	19"
Mounting depth (flush mount)	158mm
Mounting depth (recessed mount)	211mm
Height	44.45mm (1 RU)
Slot width	422mm
Total width	483mm

A separate front cover is provided with the chassis. This can be used to cover the un-used space in the mounting area. This could be required when the mounting bracket is mounted in a rack together with fan cooled equipment. The front cover will then minimize the air leakage through the mounting bracket.



The front cover is cut to the suitable size using e.g. a pair scissors at the pre-cut markings.

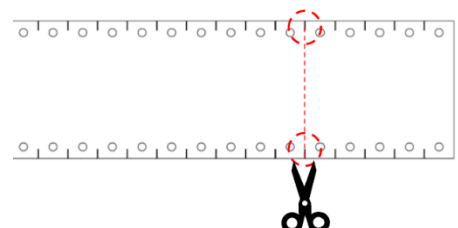

8.2 DCP-PAS-H

The DCP-PAS-H is a DCP-2 slot in unit with 21 mounting holes that can support various H-Series module combinations. The mounting slot width of the DCP-PAS-H is 204mm whilst the width of the plug-in filter units runs from 35 to 113mm, allowing a wide range of filter combinations. The H-Series filters can also be mounted in a 1-RU 19" mounting bracket with 422mm slot with, see H-CHASSI-1RU for more information.

The DCP-PAS-H has an EEPROM containing PID information about the product. This information is reported to the DCP-2 chassis for inventory information.



Figure 85: DCP-PAS-H module, to be slotted into a Smartoptics DCP-2 Chassis

PART NUMBER	DESCRIPTION
DCP-PAS-H	DCP-2 slot module for mounting of H-series

8.3 H-PPM-CHASSI-1

The H-PPM-CHASSI-1 is a module in light-weight aluminum chassis that fit Smartoptics Passive Pluggable Modules (PPM).

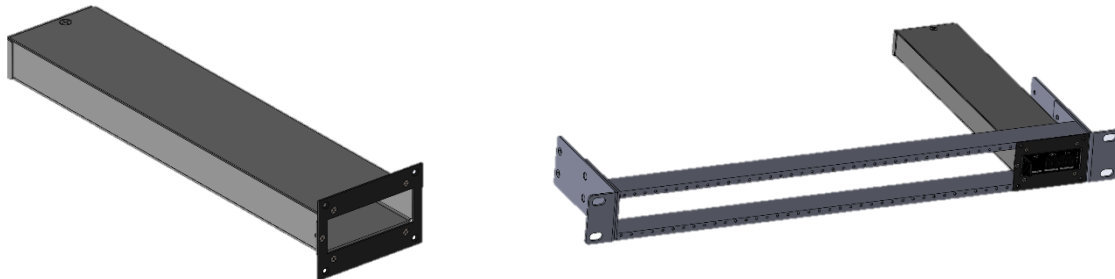

Figure 86: Images of the H-PPM-CHASSI-1 module, the module is mounted in the H-series Chassis.

The H-PPM-CHASSI-1 module is mounted in a 1 RU mounting bracket solution H-CHASSI-1RU used for mounting filter modules. The filter module sizes vary depending on type of filter and the H-PPM-CHASSI-1 can co-exist with the filters in the same mounting bracket. The mounting slot width of the H-CHASSI-1RU is 422mm whilst the width of the plug-in filter units runs from 35 to 113mm, allowing a wide range of filter combinations.

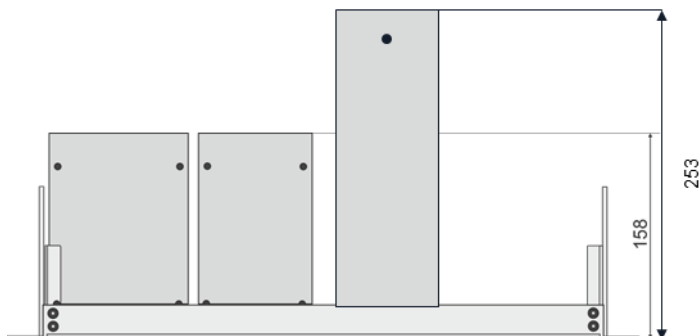

Figure 87: Top view of two H-Series filter and one H-PPM-CHASSI-1 module mounted in H-CHASSI-1RU. The length of the H-PPM-CHASSI-1 is longer, making it extend the standard module depth.

PART NUMBER	DESCRIPTION
H-PPM-CHASSI-1	H-series PPM chassis, 1 module 66mm slot

9 Technical data

In the following pages the technical data of the filters are presented.

Please note the following:

1. All filters, apart from the 40ch filters can be used in I-temperature -40°C to +85°C conditions. Please note stated operating temperature range for the filter of interest.
2. The majority of the filters have values at both C-temp and I-temp conditions. The column for I-temp conditions will then contain only those values that are different vs C-temp conditions.
3. The “typical” values are only for information only and shall not be used as base for network design. They are presented only because some vendors only present typical values to seem more competitive. In our opinion these values will only cause confusion and add risk for incorrect designs. To guarantee performance of a network design over time the worst-case values shall be used. A network system margin should also always be added to compensate for future fiber splicing, fiber ageing and transceiver performance variations.

9.1 H-AD1-Cxx

PARAMETER		C-TEMP CONDITIONS	I-TEMP CONDITIONS
Channels	H-AD1-C31	1311nm (ITU-T G.694.2)	⇐
	H-AD1-C47	1471nm (ITU-T G.694.2)	⇐
	H-AD1-C49	1491nm (ITU-T G.694.2)	⇐
	H-AD1-C51	1511nm (ITU-T G.694.2)	⇐
	H-AD1-C53	1531nm (ITU-T G.694.2)	⇐
	H-AD1-C55	1551nm (ITU-T G.694.2)	⇐
	H-AD1-C57	1571nm (ITU-T G.694.2)	⇐
	H-AD1-C59	1591nm (ITU-T G.694.2)	⇐
	H-AD1-C61	1611nm (ITU-T G.694.2)	⇐
	H-AD1-C62	1625nm	⇐
CWDM channel passband		ITU±7nm	⇐
Pass-through channel band (excluding add/drop channel)		1260 – 1620nm ¹⁾	⇐
Insertion loss, per channel Ch Rx ⇒ Line Tx / Line Rx ⇒ Ch Tx		Typical 0.9dB Max 1.1dB	Typical 1.0dB Max 1.2dB
Pass-through loss Line Rx ⇒ Ext Tx / Ext Rx ⇒ Line Tx		Typical 0.7dB Max 0.8dB	⇐
Link loss, per channel Ch Rx ⇒ Ch Tx (C)		Typical 1.5dB Max 1.7dB	⇐
Isolation, adjacent channel Line Tx/Rx ⇒ Ch Rx/Tx		Min 30dB	⇐
Isolation, non-adjacent channel Line Tx/Rx ⇒ Ch Rx/Tx		Min 40dB	⇐
Ripple, passband		Max 0.5dB	⇐
Directivity		Min 45dB	⇐
Return loss		Min 40dB	⇐
Polarization dependent loss		Max 0.2dB	⇐
Polarization mode dispersion		Max 0.20ps	⇐
Power handling		Max 300mW / +24.8dBm	⇐
Connector type		LC/UPC	⇐
Module width		45mm	⇐
Operating temperature		0°C to +70°C	-40°C to +85°C
Storage temperature		-40°C to +85°C	⇐

1) For H-AD1-C62 the pass band is defined as 1260~1598nm.

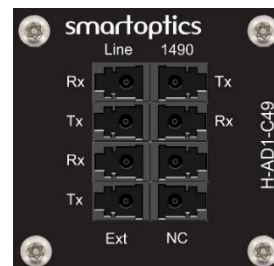
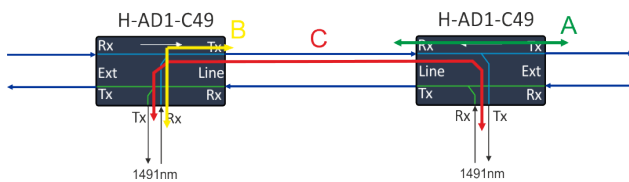

PART NUMBER	DESCRIPTION
H-AD1-C31	H-Series: 1ch CWDM AD-filter 1311nm, 45mm, Pass-through E-W= 0.8dB, AD-loss=1.1dB, LC/UPC
H-AD1-C47	H-Series: 1ch CWDM AD-filter 1471nm, 45mm, Pass-through E-W= 0.8dB, AD-loss=1.1dB, LC/UPC
H-AD1-C49	H-Series: 1ch CWDM AD-filter 1491nm, 45mm, Pass-through E-W= 0.8dB, AD-loss=1.1dB, LC/UPC
H-AD1-C51	H-Series: 1ch CWDM AD-filter 1511nm, 45mm, Pass-through E-W= 0.8dB, AD-loss=1.1dB, LC/UPC
H-AD1-C53	H-Series: 1ch CWDM AD-filter 1531nm, 45mm, Pass-through E-W= 0.8dB, AD-loss=1.1dB, LC/UPC
H-AD1-C55	H-Series: 1ch CWDM AD-filter 1551nm, 45mm, Pass-through E-W= 0.8dB, AD-loss=1.1dB, LC/UPC
H-AD1-C57	H-Series: 1ch CWDM AD-filter 1571nm, 45mm, Pass-through E-W= 0.8dB, AD-loss=1.1dB, LC/UPC
H-AD1-C59	H-Series: 1ch CWDM AD-filter 1591nm, 45mm, Pass-through E-W= 0.8dB, AD-loss=1.1dB, LC/UPC
H-AD1-C61	H-Series: 1ch CWDM AD-filter 1611nm, 45mm, Pass-through E-W= 0.8dB, AD-loss=1.1dB, LC/UPC
H-AD1-C62	H-Series: 1ch CWDM AD-filter 1625nm, 45mm, Pass-through E-W= 0.8dB, AD-loss=1.1dB, LC/UPC

9.2 H-AD1-O-1625

PARAMETER	C-TEMP CONDITIONS	I-TEMP CONDITIONS
Operating range	1260 – 1670nm	←
Add/Drop channel band	1600 – 1670nm	←
Pass-through band	1260 – 1582nm	←
Add/drop loss, 1625 ↔ Line (pass band)	0.9dB	
Pass-through loss Line Rx ⇒ Ext Tx / Ext Rx ⇒ Line Tx	0.6dB	←
Isolation 1625 @ Ext	30dB	
Isolation Ext @ OTDR 1625	26dB	
Directivity	Min 50dB	←
Return loss	Min 45dB	←
Max optical power	Max 500mW	←
Connector type	LC/UPC	←
Module width	45mm	←
Operating temperature	0°C to +70°C	-40°C to +85°C
Storage temperature	-40°C to +85°C	←

Note! A typical loss value is to be seen as a value that ~90% of a population has at beginning of life and at room temperature. The max value is the guaranteed worst-case value over time and over temperature.

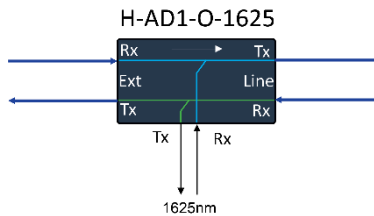
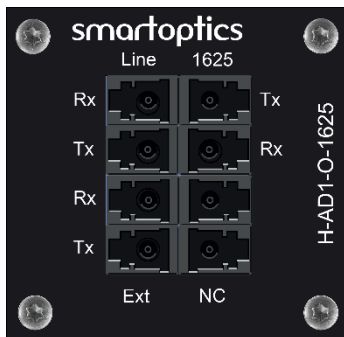

PART NUMBER	DESCRIPTION
H-AD1-O-1625	H-Series: 1ch OTDR AD-filter 1625nm, 45mm, Pass-through E-W= 0.6dB, AD-loss=0.9dB, LC/UPC

9.3 H-MD-C04L

PARAMETER	C-TEMP CONDITIONS	I-TEMP CONDITIONS
Channels	1271, 1291, 1311, 1331	←
Channel spacing	20nm	←
Channel passband	ITU±7nm	←
Link loss, per channel (A)	Typical 1.8dB Max 2.0dB	Typical 2.0dB Max 2.2dB
Insertion loss, per channel (B)	Typical 1.2dB Max 1.3dB	Typical 1.4dB Max 1.5dB
Isolation, adjacent channel	Min 30dB	←
Isolation, non-adjacent channel	Min 40dB	←
Ripple, passband	Max 0.5dB	←
Directivity	Min 45dB	←
Return loss	Min 40dB	←
Polarization dependent loss	Max 0.2dB	←
Polarization mode dispersion	Max 0.20ps	←
Connector type	LC/UPC	←
Module width	55mm	←
Operating temperature	0°C to +70°C	-40°C to +85°C
Storage temperature	-40°C to +85°C	←

Note! A typical loss value is to be seen as a value that ~90% of a population has at beginning of life and at room temperature. The max value is the guaranteed worst-case value over time and over temperature.

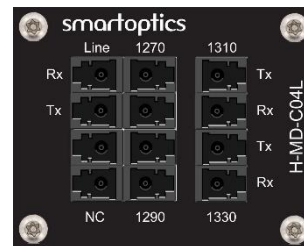
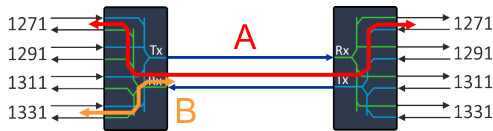

PART NUMBER	DESCRIPTION
H-MD-C04L	H-Series: 4ch CWDM Low band Mux/Demux, 1271, 1291, 1311, 1331nm, 55mm, LC/UPC

9.4 H-MD-C05

PARAMETER	C-TEMP CONDITIONS	I-TEMP CONDITIONS
Channels	1471, 1491, 1591, 1611	←
Channel spacing	20nm	←
Channel passband	ITU±7nm	←
Extension port channels	1271-1451, 1511-1571nm	←
Link loss, per channel (A)	Typical 2.5dB Max 2.8dB	Typical 2.7dB Max 3.0dB
Insertion loss, extension port (B)	Typical 1.4dB Max 1.6dB	Typical 1.6dB Max 1.8dB
Isolation, adjacent channel	Min 28dB	←
Isolation, non-adjacent channel	Min 40dB	←
Ripple, passband	Max 0.5dB	←
Directivity	Min 45dB	←
Return loss	Min 40dB	←
Polarization dependent loss	Max 0.2dB	←
Polarization mode dispersion	Max 0.20ps	←
Operating temperature	0°C to +70°C	-40°C to +85°C
Storage temperature	-40°C to +85°C	←
Connector type	LC/UPC	←
Module width	55mm	←

Note! A typical loss value is to be seen as a value that ~90% of a population has at beginning of life and at room temperature. The max value is the guaranteed worst-case value over time and over temperature.

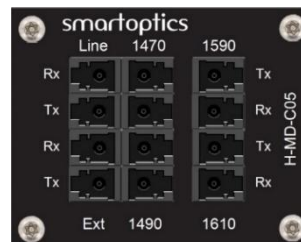
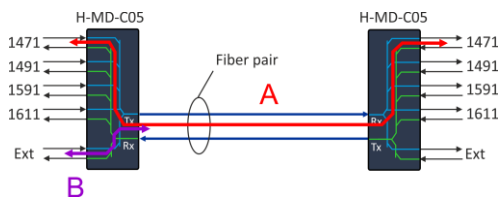

PART NUMBER	DESCRIPTION
H-MD-C05	H-Series: 4ch CWDM Mux/Demux + Ext-port, 1471, 1491, 1591, 1611nm, 55mm, LC/UPC

9.5 H-MD-C08

PARAMETER	C-TEMP CONDITIONS	I-TEMP CONDITIONS
Channels	1271, 1291, 1311, 1331, 1351, 1371, 1431, 1451	⇐
Channel spacing	20nm	⇐
Channel passband	ITU±7nm	⇐
Link loss, per channel (A)	Typical 3.6dB Max 4.0dB	Typical 3.8dB Max 4.2dB
Isolation, adjacent channel	Min 28dB	⇐
Isolation, non-adjacent channel	Min 40dB	⇐
Ripple, passband	Max 0.5dB	⇐
Directivity	Min 45dB	⇐
Return loss	Min 40dB	⇐
Polarization dependant loss	Max 0.2dB	⇐
Polarization mode dispersion	Max 0.20ps	⇐
Operating temperature	0°C to +70°C	-40°C to +85°C
Storage temperature	-40°C to +85°C	⇐
Connector type	LC/UPC	⇐
Module width	75 mm	⇐

Note! A typical loss value is to be seen as a value that ~90% of a population has at beginning of life and at room temperature. The max value is the guaranteed worst-case value over time and over temperature.

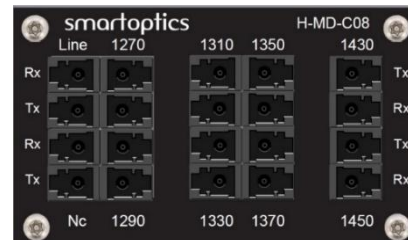
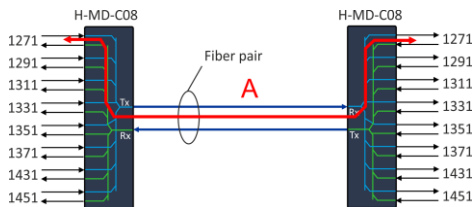

PART NUMBER	DESCRIPTION
H-MD-C08	H-Series: 8ch CWDM Mux/Demux 1271, 1291, 1311, 1331, 1351, 1371, 1431, 1451nm, 75mm, LC/UPC

9.6 H-MD-C08L-LL

PARAMETER	C-TEMP CONDITIONS	I-TEMP CONDITIONS
Operating wavelength range	1260nm to 1620nm	⇐
Channels	1271, 1291, 1311, 1331, 1351, 1371, 1431, 1451nm	⇐
Channel spacing	20nm	⇐
Channel passband	ITU±7nm	⇐
Insertion loss ch ⇔ Line (C)	Typical 2.0dB Max 2.2dB	Typical 2.2dB Max 2.4dB
Link loss, ch ⇔ Line ⇔ Line ⇔ ch (A)	Typical 2.6dB Max 3.0dB	Typical 2.8dB Max 3.2dB
Link loss, channels when combined with H-MD-C09H-E-LL (B)	Max 4.6dB	⇐
Isolation, adjacent channel	Min 30dB	⇐
Isolation, non-adjacent channel	Min 40dB	⇐
Ripple, passband	Max 0.5dB	⇐
Directivity	Min 45dB	⇐
Return loss	Min 40dB	⇐
Polarization dependent loss	Max 0.2dB	⇐
Polarization mode dispersion	Max 0.20ps	⇐
Max optical power	Max 300mW	⇐
Operating temperature	0°C to +70°C	-40°C to +85°C
Storage temperature	-40°C to +85°C	⇐
Connector type	LC/UPC	⇐
Module width	75 mm	⇐

Note! A typical loss value is to be seen as a value that ~90% of a population has at beginning of life and at room temperature. The max value is the guaranteed worst-case value over time and over temperature.

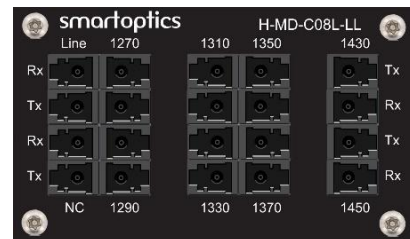
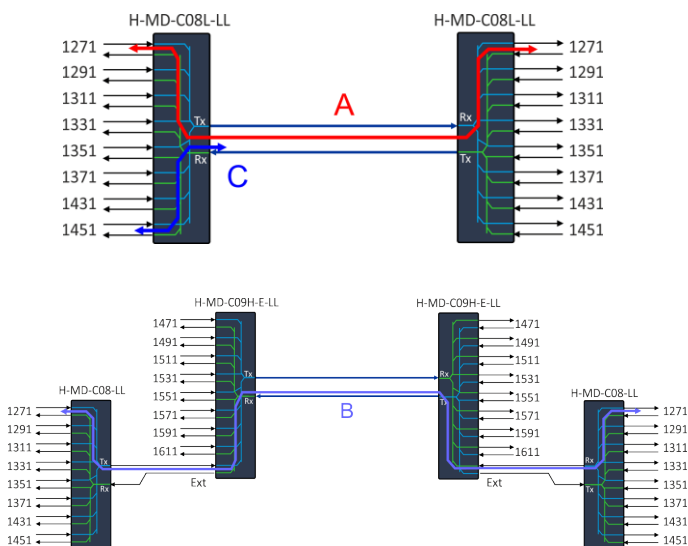

PART NUMBER	DESCRIPTION
H-MD-C08L-LL	H-Series: 8ch CWDM Low band Low Loss Mux/Demux, 1271, 1291, 1311, 1331, 1351, 1371, 1431, 1451nm, 75mm, LC/UPC

9.7 H-MD-C09

PARAMETER	C-TEMP CONDITIONS	I-TEMP CONDITIONS
Channels	1471, 1491, 1511, 1531, 1551, 1571, 1591, 1611nm	⇐
Channel spacing	20nm	⇐
Channel passband	ITU±7nm	⇐
Extension port channels	1271-1451nm	⇐
Link loss, per channel (A)	Typical 3.8dB Max 4.3dB	Typical 4.0dB Max 4.5dB
Insertion loss, extension port (B)	Typical 3.0dB Max 3.3dB	Typical 3.2dB Max 3.5dB
Isolation, adjacent channel	Min 28dB	⇐
Isolation, non-adjacent channel	Min 40dB	⇐
Ripple, passband	Max 0.5 dB	⇐
Directivity	Min 45dB	⇐
Return loss	Min 40dB	⇐
Polarization dependent loss	Max 0.2dB	⇐
Polarization mode dispersion	Max 0.20ps	⇐
Operating temperature	0°C to +70°C	-40°C to +85°C
Storage temperature	-40°C to +85°C	⇐
Connector type	LC/UPC	⇐
Module width	75 mm	⇐

Note! A typical loss value is to be seen as a value that ~90% of a population has at beginning of life and at room temperature. The max value is the guaranteed worst-case value over time and over temperature.

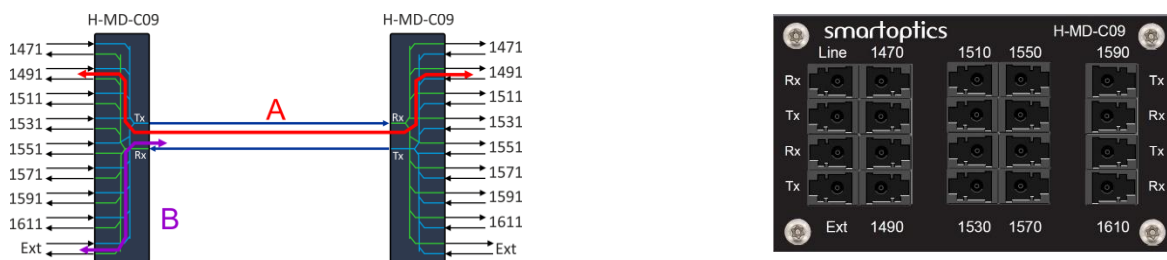

PART NUMBER	DESCRIPTION
H-MD-C09	H-Series: 8ch CWDM Mux/Demux + Ext-port, 1471, 1491, 1511, 1531, 1551, 1571, 1591, 1611, 75mm, LC/UPC

9.8 H-MD-C09H-E-LL

PARAMETER	C-TEMP CONDITIONS	I-TEMP CONDITIONS
Channels	1471, 1491, 1511, 1531, 1551, 1571, 1591, 1611nm	⇐
Channel spacing	20nm	⇐
Channel passband	ITU±7nm	⇐
Passband Extension port	1264-1458nm	⇐
Insertion loss, channels (B)	Typical 2.4dB Max 2.6dB	Typical 2.6dB Max 2.8dB
Link loss, channels (A)	Typical 2.6dB Max 3.2dB	Typical 2.8dB Max 3.4dB
Link loss, 1551nm	Typical 1.8dB Max 2.0dB	Typical 2.0dB Max 2.2dB
Insertion loss, extension port (D)	Typical 0.7dB Max 0.8dB	Typical 0.9dB Max 1.0dB
Link loss, extension ports (C)	Typical 1.5dB Max 1.6dB	Typical 1.7dB Max 1.8dB
Isolation, adjacent channel	Min 35dB	⇐
Isolation, non-adjacent channel	Min 40dB	⇐
Ripple, passband	Max 0.5dB	⇐
Directivity	Min 45dB	⇐
Return loss	Min 40dB	⇐
Polarization dependent loss	Max 0.2dB	⇐
Polarization mode dispersion	Max 0.20ps	⇐
Max optical power	Max 500mW	⇐
Operating temperature	0°C to +70°C	-40°C to +85°C
Storage temperature	-40°C to +85°C	⇐
Connector type	LC/UPC	⇐
Module width	75 mm	⇐

Note! A typical loss value is to be seen as a value that ~90% of a population has at beginning of life and at room temperature. The max value is the guaranteed worst-case value over time and over temperature.

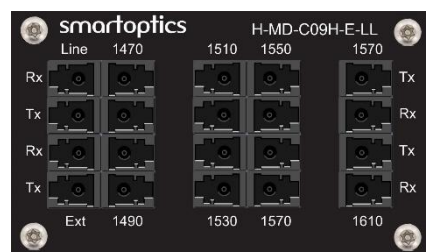
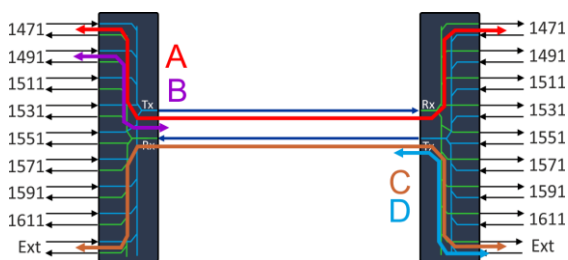

PART NUMBER	DESCRIPTION
H-MD-C09H-E-LL	H-Series: 8ch CWDM High band Low Loss Mux/Demux + Ext-port, 1471-1611nm, 75mm, LC/UPC

9.9 H-MD-09-xxx-yyy

PARAMETER	C-TEMP CONDITIONS	I-TEMP CONDITIONS
Channels H-MD-09-921-928	192.1 to 192.8 THz	←
H-MD-09-929-936	192.9 to 193.6 THz	←
H-MD-09-937-944	193.7 to 194.4 THz	←
H-MD-09-945-952	194.5 to 195.2 THz	←
H-MD-09-953-960	195.3 to 196.0 THz	←
Passband Ext-port	1525.68-1564.68nm / 191.6 to 196.5 THz excl. ch passband	←
Channel spacing	100GHz	←
Channel passband	ITU±0.11nm	←
Link loss, per channel (A)	Typical 3.8dB Max 4.3dB	Typical 4.0dB Max 4.5dB
Insertion loss, per channel (B)	Typical 2.6dB Max 2.9dB	Typical 2.8dB Max 3.1dB
Insertion loss, extension port (C)	Typical 3.0dB Max 3.2dB	Typical 3.2dB Max 3.5dB
Insertion loss, monitor	18dB to 22dB	←
Isolation, adjacent channel	Min 28dB	←
Isolation, non-adjacent channel	Min 40dB	←
Ripple, passband	Max 0.5dB	←
Directivity	Min 45dB	←
Return loss	Min 40dB	←
Polarization dependent loss	Max 0.2dB	←
Polarization mode dispersion	Max 0.20ps	←
Max optical power	Max 500mW	←
Operating temperature	0°C to +70°C	-40°C to +85°C
Storage temperature	-40°C to +85°C	←
Connector type	LC/U/PC	←

Note! A typical loss value is to be seen as a value that ~90% of a population has at beginning of life and at room temperature. The max value is the guaranteed worst-case value over time and over temperature.

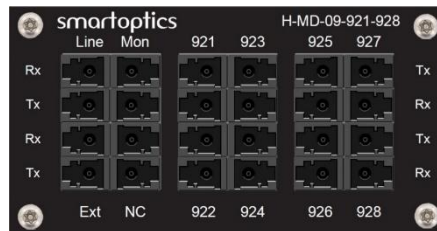
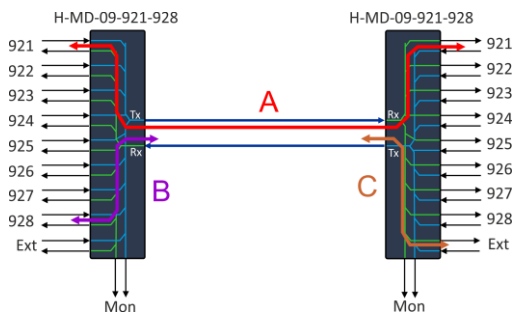

PART NUMBER	DESCRIPTION
H-MD-09-921-928	H-Series: 8ch DWDM Mux/Demux + Ext- & Mon-port, 192.1 to 192.8THz, 84mm, LC/U/PC
H-MD-09-929-936	H-Series: 8ch DWDM Mux/Demux + Ext- & Mon-port, 192.9 to 193.6THz, 84mm, LC/U/PC
H-MD-09-937-944	H-Series: 8ch DWDM Mux/Demux + Ext- & Mon-port, 193.7 to 194.4THz, 84mm, LC/U/PC
H-MD-09-945-952	H-Series: 8ch DWDM Mux/Demux + Ext- & Mon-port, 194.5 to 195.2THz, 84mm, LC/U/PC
H-MD-09-953-960	H-Series: 8ch DWDM Mux/Demux + Ext- & Mon-port, 195.3 to 195.6THz, 84mm, LC/U/PC

9.10 H-MD-09-xxx-yyy-EM-LL

PARAMETER	C-TEMP CONDITIONS	I-TEMP CONDITIONS
Channels H-MD-09-921-928-EM-LL	192.1 to 192.8THz	⇐
H-MD-09-929-936-EM-LL	192.9 to 193.6THz	⇐
H-MD-09-937-944-EM-LL	193.7 to 194.4THz	⇐
H-MD-09-945-952-EM-LL	194.5 to 195.2THz	⇐
H-MD-09-953-960-EM-LL	195.3 to 196.0THz	⇐
Passband Ext-port	1504 -1580nm / 189.7 to 199.33THz excl. ch passband	⇐
Channel spacing	100GHz	⇐
Channel passband	ITU±0.11nm	⇐
Link loss, per channel (A)	Typical 4.3dB Max 4.8dB	Typical 4.5dB Max 5.0dB
Insertion loss, per channel (B)	Typical 2.5dB Max 2.8dB	Typical 2.7dB Max 3.0dB
Link loss, extension port (C)	Typical 1.6dB Max 1.7dB	Typical 1.8dB Max 1.9dB
Insertion loss, extension port (D)	Typical 0.8dB Max 1.0dB	⇐
Insertion loss, monitor	18dB to 22dB	⇐
Isolation, adjacent channel	30dB	⇐
Isolation, non-adjacent channel	Min 40dB	⇐
Ripple, passband	Max 0.5dB	⇐
Directivity	Min 45dB	⇐
Return loss	Min 45dB	⇐
Polarization dependent loss	Max 0.2dB	⇐
Polarization mode dispersion	Max 0.20ps	⇐
Operating temperature	0°C to +70°C	-40°C to +85°C
Storage temperature	-40°C to +85°C	⇐
Max optical power	Max 300mW	⇐
Connector type	LC/UPC	⇐
Module width	84mm	⇐

Note! A typical loss value is to be seen as a value that ~90% of a population has at beginning of life and at room temperature. The max value is the guaranteed worst-case value over time and over temperature.

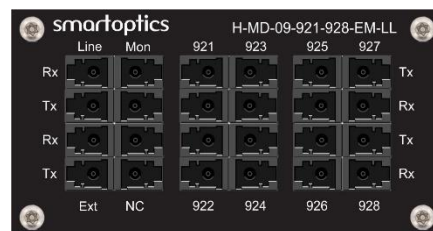
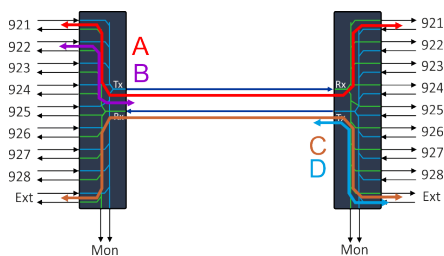

PART NUMBER	DESCRIPTION
H-MD-09-921-928-EM-LL	H-Series: 8ch DWDM Low Loss Mux/Demux + Ext-& Mon-port, 921-928, 84mm, LC/UPC
H-MD-09-929-936-EM-LL	H-Series: 8ch DWDM Low Loss Mux/Demux + Ext-& Mon-port, 929-936, 84mm, LC/UPC
H-MD-09-937-944-EM-LL	H-Series: 8ch DWDM Low Loss Mux/Demux + Ext-& Mon-port, 937-944, 84mm, LC/UPC
H-MD-09-945-952-EM-LL	H-Series: 8ch DWDM Low Loss Mux/Demux + Ext-& Mon-port, 945-952, 84mm, LC/UPC
H-MD-09-953-960-EM-LL	H-Series: 8ch DWDM Low Loss Mux/Demux + Ext-& Mon-port, 953-960, 84mm, LC/UPC

9.11 H-MD-09-xxx-yyy-4C

PARAMETER	C-TEMP CONDITIONS	I-TEMP CONDITIONS
Channels H-MD-09-921-928-4C	192.1 to 192.8 THz	←
H-MD-09-929-936-4C	192.9 to 193.6 THz	←
H-MD-09-937-944-4C	193.7 to 194.4 THz	←
H-MD-09-945-952-4C	194.5 to 195.2 THz	←
H-MD-09-953-960-4C	195.3 to 196.0 THz	←
Channel spacing	100GHz ITU G.694.1	←
Channel passband -3dB	Min 72.5GHz	←
Passband Ext-port	1264 -1630nm / 183.9 to 237.2THz excl. ch passband	←
Link loss, per channel (A)	Max 4.6dB	Max 5.2dB
Insertion loss, per channel (B)	Max 3.0dB	Max 3.5dB
Insertion loss, extension port (C)	Max 0.9dB	Max 1.0dB
Link loss, extension port (D)	Max 1.8dB	Max 2.0dB
Insertion loss, monitor	18-22dB without including the mux, demux or passband loss	←
Isolation, adjacent channel	Min 28dB	←
Isolation, non-adjacent channel	Min 40dB	←
Ripple, passband	Max 0.5dB	←
Directivity	Min 45dB	←
Return loss	Min 40dB	←
Max power handling	Max 500mW	←
Operating temperature	0°C to +70 °C	-40°C to +85 °C
Storage temperature	-40°C to +85 °C	←
Connector type	LC/UPC	←
Module width	84mm	←

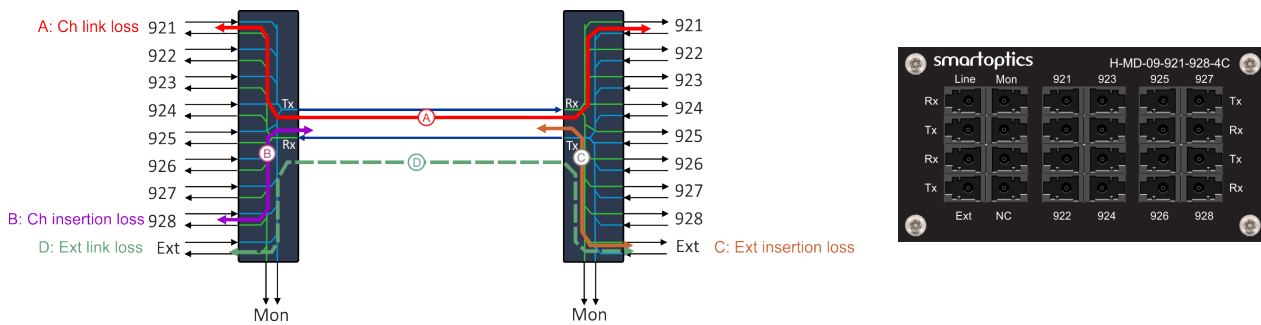

PART NUMBER	DESCRIPTION
H-MD-09-921-928-4C	8ch DWDM 400G Mux/Demux, Ext+Mon 921-928
H-MD-09-929-936-4C	8ch DWDM 400G Mux/Demux, Ext+Mon 929-936
H-MD-09-937-944-4C	8ch DWDM 400G Mux/Demux, Ext+Mon 937-944
H-MD-09-945-952-4C	8ch DWDM 400G Mux/Demux, Ext+Mon 945-952
H-MD-09-953-960-4C	8ch DWDM 400G Mux/Demux, Ext+Mon 953-960

9.12 H-MD-16-xxx-yyy

PARAMETER	C-TEMP CONDITIONS	I-TEMP CONDITIONS
Channels H-MD-16-921-936	192.1 to 193.6THz	⇐
H-MD-16-937-952	193.7 to 195.2THz	⇐
Passband Ext-port	1520-1580nm / 189.7 to 197.2THz excl. ch passband	⇐
Channel spacing	100GHz	⇐
Channel passband	ITU±0.11nm	⇐
Link loss, per channel (A)	Typical 5.7dB Max 6.3dB	Typical 5.9dB Max 6.5dB
Insertion loss, per channel (B)	Typical 3.8dB Max 4.2dB	Typical 4.0dB Max 4.4dB
Insertion loss, extension port (C)	Typical 4.1dB Max 4.6dB	Typical 4.3dB Max 4.8dB
Insertion loss, monitor	18dB to 22dB	⇐
Isolation, adjacent channel	Min 28dB	⇐
Isolation, non-adjacent channel	Min 40dB	⇐
Ripple, passband	Max 0.5dB	⇐
Directivity	Min 45dB	⇐
Return loss	Min 40dB	⇐
Polarization dependent loss	Max 0.2dB	⇐
Polarization mode dispersion	Max 0.20ps	⇐
Operating temperature	0°C to +70°C	-40°C to +85°C
Storage temperature	-40°C to +85°C	⇐
Max optical power	Max 300mW	⇐
Connector type	LC/UPC	⇐
Module width	113mm	⇐

Note! A typical loss value is to be seen as a value that ~90% of a population has at beginning of life and at room temperature. The max value is the guaranteed worst-case value over time and over temperature.

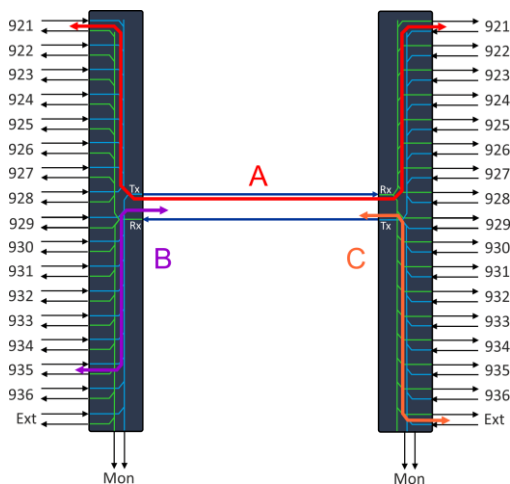

PART NUMBER	DESCRIPTION
H-MD-16-921-936	H-Series: 16ch DWDM Mux/Demux + Ext- & Mon-port, 192.1 to 193.6THz, 113mm, LC/UPC
H-MD-16-937-952	H-Series: 16ch DWDM Mux/Demux + Ext- & Mon-port, 193.7 to 195.2THz, 113mm, LC/UPC

9.13 H-MD-40-921-960

PARAMETER

Channels	192.1 to 196.0 THz
Channel spacing	100GHz ± 33GHz (ITU)
Channel passband 1.5dB	60GHz
Channel passband 3.0dB	80GHz
Insertion loss, per channel (ch Rx ⇒ Line Tx)	Typical 5.4dB Max 5.9 dB
Insertion loss, monitor	18dB to 22dB
Isolation, adjacent channel ¹⁾	Min 8dB
Isolation, non-adjacent channel ²⁾	Min 5dB
Ripple, passband	Max 1.0dB
Return loss	Min 40dB
Chromatic dispersion	Min -20ps/nm Max 20ps/nm
Polarization mode dispersion	Max 0.70ps
Connector type	LC/UPC
Dimensions	1RU height, 19" rack mount
Operating temperature	-5 to + 65 °C
Storage temperature	-40 to + 85 °C
Max optical power	Max 24dBm (251mW)

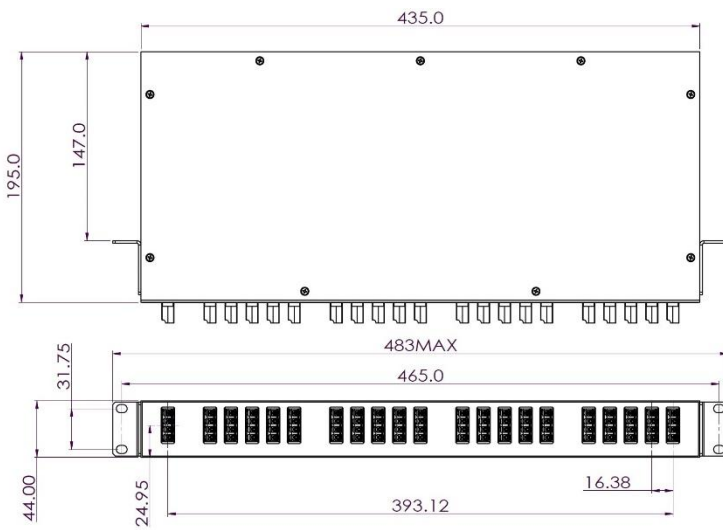

1) Maximum insertion loss difference from the mean transmission at the ITU grid wavelength to the highest power, all polarizations, within the ITU band of the two adjacent channels.

2) Total cumulative insertion loss difference from the mean transmission at the ITU grid wavelength to the highest power, all polarizations, within the ITU band of all other channels, including adjacent channels.

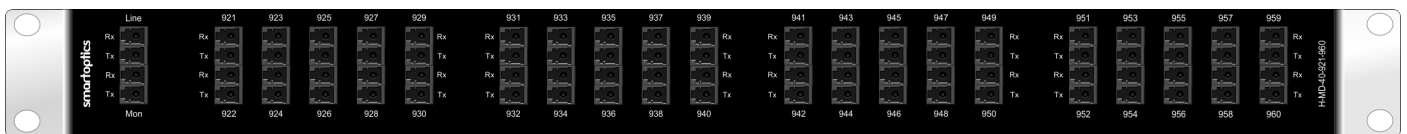

PART NUMBER

DESCRIPTION

H-MD-40-921-960

H-Series: 1RU 19", 40ch DWDM Mux/Demux + Mon-port, 192.1 to 196.0THz, LC/UPC

9.14 H-MD-48-914-961

PARAMETER

Channels	191.4 to 196.1 THz
Channel spacing	100GHz ± 33GHz (ITU)
Channel passband 1.5dB	60GHz
Channel passband 3.0dB	80GHz
Insertion loss, per channel (ch Rx ⇒ Line Tx)	Typical 5.4dB Max 5.9 dB
Insertion loss, monitor	18dB to 22dB
Isolation, adjacent channel ¹⁾	Min 7.3dB
Isolation, adjacent channel, typical ²⁾	Min 20dB
Isolation, non-adjacent channel, typical ²⁾	Min 35dB
Total Crosstalk ¹⁾	Min 5dB
Ripple, passband	Max 0.5dB
Return loss	Min 40dB
Chromatic dispersion	Min -20ps/nm Max 20ps/nm
Polarization mode dispersion	Max 0.70ps
Connector type	LC/UPC
Dimensions	1RU height, 19" rack mount
Operating temperature	-5 to + 65 °C
Storage temperature	-40 to + 85 °C
Max optical power	Max 24dBm (251mW)

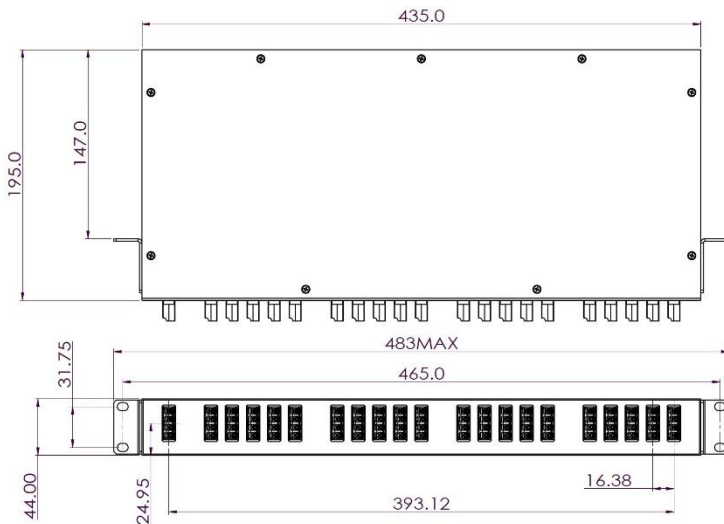

1) Difference between the insertion loss in channel and the minimum loss over all other channels, for all polarization states, under the worst case in the guard band.

2) The typical value reflects a 10G NRZ modulated signal located in the middle of the ITU-channel.



PART NUMBER

DESCRIPTION

H-MD-48-914-961 H-Series: 1RU 19", 48ch DWDM Mux/Demux + Mon-port, 191.4 to 196.1THz, Link-loss channel=11.8dB, Insertion-loss channel=5.9dB, LC/UPC

9.15 H-MD-09-xxxx-yyyy-8C

PARAMETER	C-TEMP CONDITIONS	I-TEMP CONDITIONS ¹⁾
Channels H-MD-09-9140-9245-8C	191.4 to 192.45 THz	⇐ (same as C-temp)
H-MD-09-9260-9365-8C	192.6 to 193.65 THz	⇐
H-MD-09-9380-9485-8C	193.8 to 194.85 THz	⇐
H-MD-09-9500-9605-8C	195.0 to 196.05 THz	⇐
Channel spacing	150GHz	⇐
Channel passband -1dB	≥ 75.0GHz	⇐
Channel passband -3dB	≥ 135.0GHz	⇐
Passband Ext-port	1520 -1620nm, excl. ch passband	⇐
Link loss, per channel (A)	≤ 4.6dB	≤ 5.2dB
Insertion loss, per channel (B)	≤ 3.0dB	≤ 3.5dB
Insertion loss, extension port	≤ 2.0dB	≤ 2.3dB
Link loss, extension port (C)	≤ 4.0dB	≤ 4.6dB
Insertion loss, monitor	18-22dB without including the mux, demux or passband loss	⇐
Isolation, adjacent channel	≥ 20dB	⇐
Isolation, non-adjacent channel	≥ 35dB	⇐
Ripple, passband	≤ 0.5dB	⇐
Directivity	≥ 55dB	⇐
Return loss	≥ 45dB	⇐
Max power handling	Max 500mW	⇐
Operating temperature	0°C to +70 °C	-40°C to +85 °C
Storage temperature	-40°C to +85 °C	⇐
Connector type	LC/UPC	⇐
Module width	84mm	⇐

The I-temp column only shows values that differ from C-temp conditions.

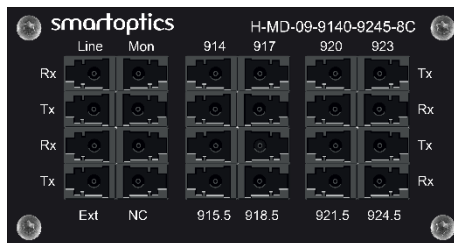
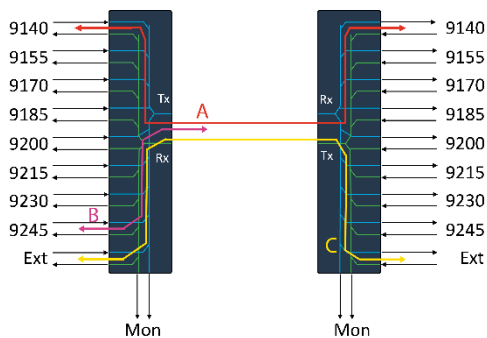

PART NUMBER	DESCRIPTION
H-MD-09-9140-9245-8C	8ch DWDM 800G Mux/Demux, E+M 9140-9245
H-MD-09-9260-9365-8C	8ch DWDM 800G Mux/Demux, E+M 9260-9365
H-MD-09-9380-9485-8C	8ch DWDM 800G Mux/Demux, E+M 9380-9485
H-MD-09-9500-9605-8C	8ch DWDM 800G Mux/Demux, E+M 9500-9605

9.16 H-MD-32-9140-9605

PARAMETER

Channels	191.4 to 196.05 THz
Channel spacing	150GHz
Channel passband 1.0dB	100GHz
Channel passband 3.0dB	150GHz
Insertion loss, per channel (ch Rx => Line Tx)	Max 6.0dB
Insertion loss, Line Rx -> Mon Rx	18dB to 22dB
Insertion loss, Channel Rx -> Mon Tx	28dB
Isolation, adjacent channel ¹⁾	Min 9dB
Isolation, non-adjacent channel ²⁾	Min 30dB
Ripple, passband	Max 0.5dB
Return loss	Min 40dB
Chromatic dispersion	Min -20ps/nm Max 20ps/nm
Polarization mode dispersion	Max 1.0ps
Connector type	LC/UPC
Dimensions	1RU height, 19" rack mount
Operating temperature	-5 to + 65 °C
Storage temperature	-40 to + 85 °C
Max optical power	Max 24dBm (251mW)

1) Maximum insertion loss difference from the mean transmission at the 150GHz grid wavelength to the highest power, all polarizations, within the band of the two adjacent channels.

2) Total cumulative insertion loss difference from the mean transmission at the 150GHz grid wavelength to the highest power, all polarizations, within the band of the two adjacent channels.

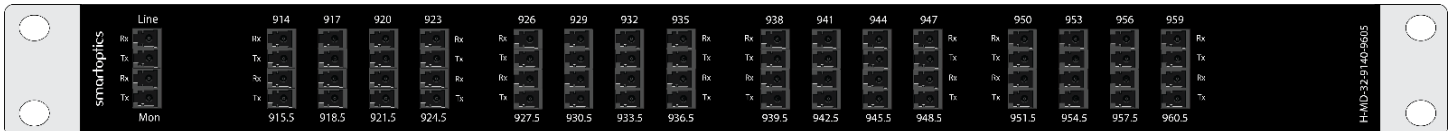

9.17 Order information

PART NUMBER DESCRIPTION

H-MD-32-9140-9605 H-Series: 1RU 19", 32ch, DWDM Mux/Demux + Mon-port, 191.4-196.05THz, Insertion-loss channel=6.0dB, LC/UPC

9.18 M-3840-LL

PARAMETER	
Channels	192.1 to 196.0 THz
Channel spacing	100GHz
Channel passband 0.5dB	ITU±0.11nm
Insertion loss, per channel (ch Rx ⇒ Line Tx)	Typical 5.4dB Max 6.0dB
Link loss, per channel (ch Rx ⇒ ch Tx)	Typical 6.8dB Max 7.5dB
Isolation, adjacent channel (Line Tx/Rx<=>chxx Rx/Tx)	Min 30dB
Isolation, non-adjacent channel (Line Tx/Rx<=>chxx Rx/Tx)	Min 40dB
Ripple, passband	Max 0.5dB
Return loss	Min 45dB
Chromatic dispersion	Min -20ps/nm Max 20ps/nm
Polarization dependent loss	Max 0.2dB
Polarization Mode Dispersion	Max 0.5ps
Connector type	LC/UPC
Dimensions	1RU height, 19" rack mount
Operating temperature	0 to +70 °C
Storage temperature	-40 to +85 °C
Max optical power	Max 300mW / +24.7dBm

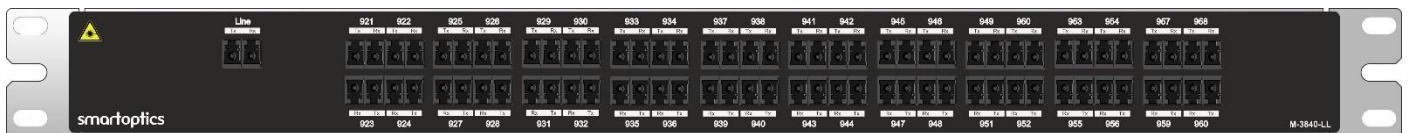
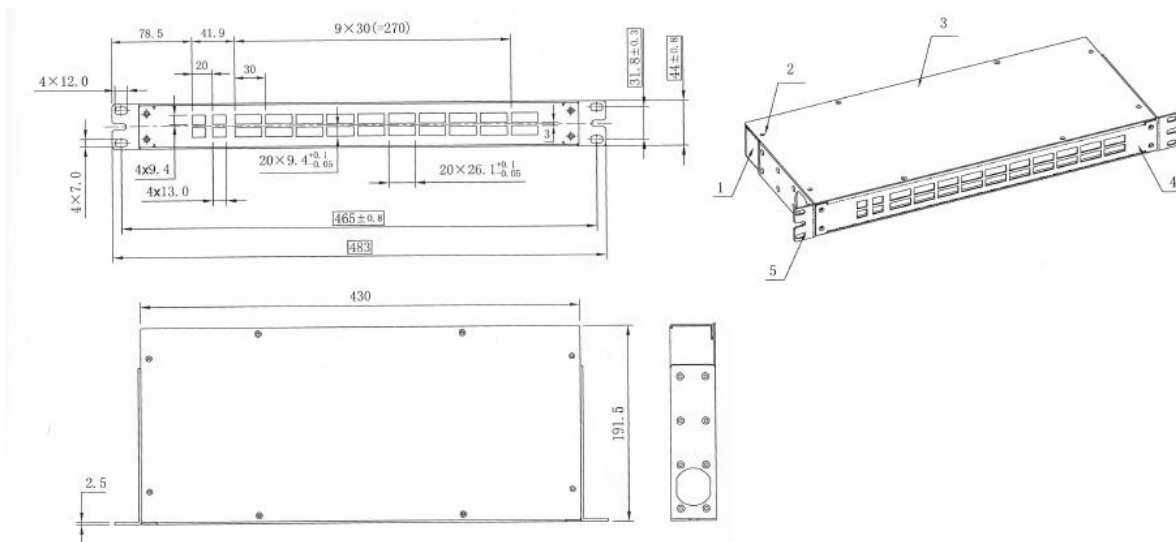

PART NUMBER	DESCRIPTION
M-3840-LL	1RU, 19", D=191.5mm, 40ch DWDM Mux/Demux LowLoss, 100GHz D921-D960, LC/UPC

9.19 H-OADM1x4-xxx-yyy

PARAMETER	C-TEMP CONDITIONS	I-TEMP CONDITIONS
Passband Ext ↔ Line	1500nm to 1600nm	↔
Channels	See ordering information table	↔
Channel spacing	100GHz	↔
Channel passband	ITU±0.11nm	↔
Insertion loss, pass-through E-W (A)	Typical 1.2dB Max 1.6dB	Typical 1.6dB Max 1.8dB
Add/drop loss (B)	Typical 2.0dB Max 2.3dB	Typical 2.2dB Max 2.5dB
Link loss, per channel (C)	Typical 3.1dB Max 3.3dB	Typical 3.2dB Max 3.5dB
Insertion loss, monitor	18dB to 22dB	↔
Isolation, adjacent channel	Min 28dB	↔
Isolation, non-adjacent channel	Min 40dB	↔
Ripple, passband	Max 0.5dB	↔
Directivity	Min 45dB	↔
Return loss	Min 40dB	↔
Polarization dependent loss	Max 0.2dB	↔
Polarization mode dispersion	Max 0.20ps	↔
Connector type	LC/UPC	↔
Operating temperature	0°C to +70°C	-40°C to +85°C
Storage temperature	-40°C to +85°C	↔
Max optical power	Max 500mW	↔
Module width	65 mm	↔

Note! A typical loss value is to be seen as a value that ~90% of a population has at beginning of life and at room temperature. The max value is the guaranteed worst-case value over time and over temperature.

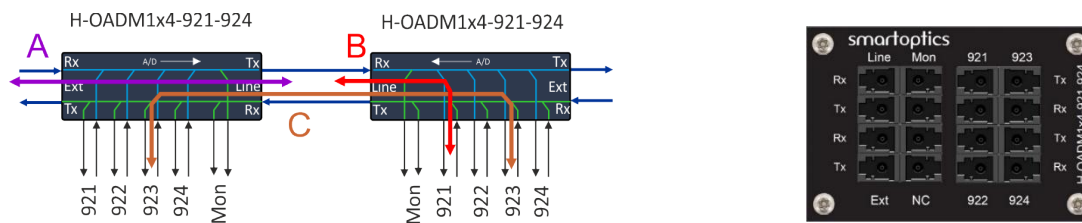

PART NUMBER	DESCRIPTION
H-OADM1x4-921-924	H-Series: 4ch DWDM 1-way OADM + Mon-port, 192.1 to 192.4THz, 65mm, LC/UPC
H-OADM1x4-925-928	H-Series: 4ch DWDM 1-way OADM + Mon-port, 192.5 to 192.8THz, 65mm, LC/UPC
H-OADM1x4-929-932	H-Series: 4ch DWDM 1-way OADM + Mon-port, 192.9 to 193.2THz, 65mm, LC/UPC
H-OADM1x4-933-936	H-Series: 4ch DWDM 1-way OADM + Mon-port, 193.3 to 193.6THz, 65mm, LC/UPC
H-OADM1x4-937-940	H-Series: 4ch DWDM 1-way OADM + Mon-port, 193.7 to 194.0THz, 65mm, LC/UPC
H-OADM1x4-941-944	H-Series: 4ch DWDM 1-way OADM + Mon-port, 194.1 to 194.4THz, 65mm, LC/UPC
H-OADM1x4-945-948	H-Series: 4ch DWDM 1-way OADM + Mon-port, 194.5 to 194.8THz, 65mm, LC/UPC
H-OADM1x4-949-952	H-Series: 4ch DWDM 1-way OADM + Mon-port, 194.9 to 195.2THz, 65mm, LC/UPC
H-OADM1x4-953-956	H-Series: 4ch DWDM 1-way OADM + Mon-port, 195.3 to 195.6THz, 65mm, LC/UPC
H-OADM1x4-957-960	H-Series: 4ch DWDM 1-way OADM + Mon-port, 195.7 to 196.0THz, 65mm, LC/UPC

9.20 H-OADM2x4-xxx-yyy

PARAMETER	C-TEMP CONDITIONS	I-TEMP CONDITIONS
Passband Line ↔ Line	1500nm to 1600nm	↔
Channels	See ordering information table	↔
Channel spacing	100 GHz	↔
Channel passband	ITU±0.11 nm	↔
Insertion loss, pass-through E-W (A)	Typical 2.7dB Max 3.0dB	Typical 2.9dB Max 3.2dB
Add/drop loss (B)	Typical 2.0dB Max 2.3dB	Typical 2.2dB Max 2.5dB
Link loss, per channel (C)	Typical 3.0dB Max 3.3dB	Typical 3.2dB Max 3.5dB
Insertion loss, monitor	18dB to 22dB	↔
Isolation, adjacent channel	Min 28dB	↔
Isolation, non-adjacent channel	Min 40dB	↔
Ripple, passband	Max 0.5dB	↔
Directivity	Min 45dB	↔
Return loss	Min 40dB	↔
Polarization dependent loss	Max 0.2dB	↔
Polarization mode dispersion	Max 0.20ps	↔
Operating temperature	0°C to +70°C	-40°C to +85°C
Storage temperature	-40°C to +85°C	↔
Max optical power	Max 500mW	↔
Connector type	LC/UPC	↔
Module width	84 mm	↔

Note! A typical loss value is to be seen as a value that ~90% of a population has at beginning of life and at room temperature. The max value is the guaranteed worst-case value over time and over temperature.

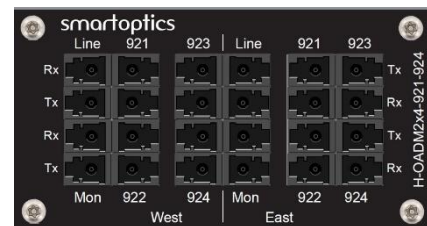
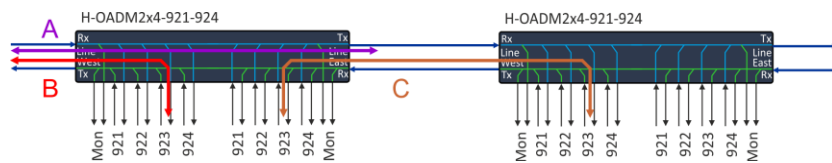

PART NUMBER	DESCRIPTION
H-OADM2x4-921-924	H-Series: 4ch DWDM 2-way OADM + Mon-port, 192.1 to 192.4THz, 84mm, LC/UPC
H-OADM2x4-925-928	H-Series: 4ch DWDM 2-way OADM + Mon-port, 192.5 to 192.8THz, 84mm, LC/UPC
H-OADM2x4-929-932	H-Series: 4ch DWDM 2-way OADM + Mon-port, 192.9 to 193.2THz, 84mm, LC/UPC
H-OADM2x4-933-936	H-Series: 4ch DWDM 2-way OADM + Mon-port, 193.3 to 193.6THz, 84mm, LC/UPC
H-OADM2x4-937-940	H-Series: 4ch DWDM 2-way OADM + Mon-port, 193.7 to 194.0THz, 84mm, LC/UPC
H-OADM2x4-941-944	H-Series: 4ch DWDM 2-way OADM + Mon-port, 194.1 to 194.4THz, 84mm, LC/UPC
H-OADM2x4-945-948	H-Series: 4ch DWDM 2-way OADM + Mon-port, 194.5 to 194.8THz, 84mm, LC/UPC
H-OADM2x4-949-952	H-Series: 4ch DWDM 2-way OADM + Mon-port, 194.9 to 195.2THz, 84mm, LC/UPC
H-OADM2x4-953-956	H-Series: 4ch DWDM 2-way OADM + Mon-port, 195.3 to 195.6THz, 84mm, LC/UPC
H-OADM2x4-957-960	H-Series: 4ch DWDM 2-way OADM + Mon-port, 195.7 to 196.0THz, 84mm, LC/UPC

9.21 H-OADM1x4-xxx-yyy-4C

PARAMETER	C-TEMP CONDITIONS	I-TEMP CONDITIONS
Channels H-OADM1x4-921-924-4C	921, 922, 923, 924	← (same as C-temp)
H-OADM1x4-925-928-4C	925, 926, 927, 928	←
H-OADM1x4-929-932-4C	929, 930, 931, 932	←
H-OADM1x4-933-936-4C	933, 934, 935, 936	←
H-OADM1x4-937-940-4C	937, 938, 939, 940	←
H-OADM1x4-941-944-4C	941, 942, 943, 944	←
H-OADM1x4-945-948-4C	945, 946, 947, 948	←
H-OADM1x4-949-952-4C	949, 950, 951, 952	←
H-OADM1x4-953-956-4C	953, 954, 955, 956	←
H-OADM1x4-957-960-4C	957, 958, 959, 960	←
Channel spacing	100GHz ITU G.694.1	←
Channel passband -3dB	Min 72.5GHz	←
Passband Ext Rx ↔ Line Tx, excl add/drop ch	1264 -1630nm / 183.9 to 237.2THz excl. ch passband	←
Insertion loss Ext Rx ↔ Line Tx (A)	≤ 0.9dB	≤ 1.0dB
Channel insertion loss: Line Rx ↔ Ch Tx (B)	≤ 2.2dB	≤ 2.5dB
Channel link loss, Ch Rx ↔ Line Tx ↔ Line Rx ↔ Ch Tx (C)	≤ 3.6dB	≤ 4.0dB
Insertion loss, monitor	18-22dB without including the mux, demux or passband loss	←
Isolation, adjacent channel	≥ 28dB	←
Isolation, non-adjacent channel	≥ 40dB	←
Ripple, passband	≤ 0.5dB	←
Directivity	≥ 45dB	←
Return loss	≥ 40dB	←
Max power handling	Up to 500mW	←
Operating temperature	0°C - +70 °C	-40°C - +85 °C
Connector type	LC/UPC	←
Module width	65mm	←

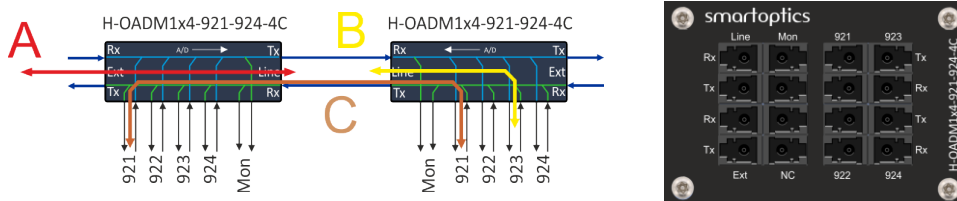

PART NUMBER	DESCRIPTION
H-OADM1x4-921-924-4C	4ch DWDM 400G 1-way OADM + Mon, 921-924
H-OADM1x4-925-928-4C	4ch DWDM 400G 1-way OADM + Mon, 925-928
H-OADM1x4-929-932-4C	4ch DWDM 400G 1-way OADM + Mon, 929-932
H-OADM1x4-933-936-4C	4ch DWDM 400G 1-way OADM + Mon, 933-936
H-OADM1x4-937-940-4C	4ch DWDM 400G 1-way OADM + Mon, 937-940
H-OADM1x4-941-944-4C	4ch DWDM 400G 1-way OADM + Mon, 941-944
H-OADM1x4-945-948-4C	4ch DWDM 400G 1-way OADM + Mon, 945-948
H-OADM1x4-949-952-4C	4ch DWDM 400G 1-way OADM + Mon, 949-952
H-OADM1x4-953-956-4C	4ch DWDM 400G 1-way OADM + Mon, 953-956
H-OADM1x4-957-960-4C	4ch DWDM 400G 1-way OADM + Mon, 957-960

9.22 H-OADM2x4-xxx-yyy-4C

PARAMETER	C-TEMP CONDITIONS	I-TEMP CONDITIONS
Channels H-OADM2x4-921-924-4C	192.1 to 192.4 THz	← (same as C-temp)
H-OADM2x4-925-928-4C	192.5 to 192.8 THz	←
H-OADM2x4-929-932-4C	192.9 to 193.2 THz	←
H-OADM2x4-933-936-4C	193.3 to 193.6 THz	←
H-OADM2x4-937-940-4C	193.7 to 194.0 THz	←
H-OADM2x4-941-944-4C	194.1 to 194.4 THz	←
H-OADM2x4-945-948-4C	194.5 to 194.8 THz	←
H-OADM2x4-949-952-4C	194.9 to 195.2 THz	←
H-OADM2x4-953-956-4C	195.3 to 195.6 THz	←
H-OADM2x4-957-960-4C	195.7 to 196.0 THz	←
Channel spacing	100GHz ITU G.694.1	←
Channel passband -3dB	Min 72.5GHz	←
Passband Ext Rx ↔ Line Tx, excl add/drop ch	1264 -1630nm / 183.9 to 237.2THz excl. ch passband	←
Insertion loss Ext Rx ↔ Line Tx (A)	≤ 1.8dB ≤ 2.4dB between 1375-1405nm ¹⁾	≤ 2.0dB ≤ 2.6dB between 1375-1405nm ¹⁾
Channel insertion loss: Line Rx ↔ Ch Tx (B)	≤ 2.2dB	≤ 2.8dB
Channel link loss, Ch Rx ↔ Line Tx ↔ Line Rx ↔ Ch Tx (C)	≤ 3.6dB	≤ 4.5dB
Insertion loss, monitor	18-22dB without including the mux, demux or passband loss	←
Isolation, adjacent channel	≥ 28dB	←
Isolation, non-adjacent channel	≥ 40dB	←
Ripple, passband	≤ 0.5dB	←
Directivity	≥ 45dB	←
Return loss	≥ 40dB	←
Max power handling	Up to 500mW	←
Operating temperature	0°C - +70 °C	-40°C - +85 °C
Connector type	LC/UPC	←
Module width	84mm	←

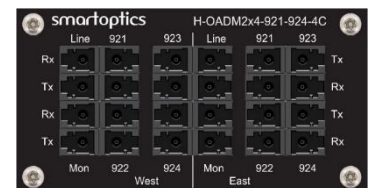
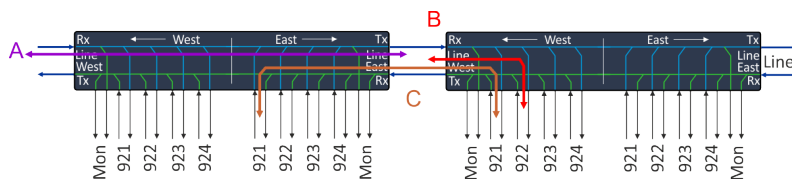

PART NUMBER	DESCRIPTION
H-OADM2x4-921-924-4C	4ch DWDM 400G 2-way OADM + Mon, 921-924
H-OADM2x4-925-928-4C	4ch DWDM 400G 2-way OADM + Mon, 925-928
H-OADM2x4-929-932-4C	4ch DWDM 400G 2-way OADM + Mon, 929-932
H-OADM2x4-933-936-4C	4ch DWDM 400G 2-way OADM + Mon, 933-936
H-OADM2x4-937-940-4C	4ch DWDM 400G 2-way OADM + Mon, 937-940
H-OADM2x4-941-944-4C	4ch DWDM 400G 2-way OADM + Mon, 941-944
H-OADM2x4-945-948-4C	4ch DWDM 400G 2-way OADM + Mon, 945-948
H-OADM2x4-949-952-4C	4ch DWDM 400G 2-way OADM + Mon, 949-952
H-OADM2x4-953-956-4C	4ch DWDM 400G 2-way OADM + Mon, 953-956
H-OADM2x4-957-960-4C	4ch DWDM 400G 2-way OADM + Mon, 957-960

9.23 H-OADM1x2-xxx-yyy-4C

PARAMETER	C-TEMP CONDITIONS	I-TEMP CONDITIONS	
Channels	H-OADM1x2-921-922-4C ; H-OADM1x2-923-924-4C	921, 922 ; 923, 924	⇐ (same as C-temp)
	H-OADM1x2-925-926-4C ; H-OADM1x2-927-928-4C	925, 926 ; 927, 928	⇐
	H-OADM1x2-929-930-4C ; H-OADM1x2-931-932-4C	929, 930 ; 931, 932	⇐
	H-OADM1x2-933-934-4C ; H-OADM1x2-935-936-4C	933, 934 ; 935, 936	⇐
	H-OADM1x2-937-938-4C ; H-OADM1x2-939-940-4C	937, 938 ; 939, 940	⇐
	H-OADM1x2-941-942-4C ; H-OADM1x2-943-944-4C	941, 942 ; 943, 944	⇐
	H-OADM1x2-945-946-4C ; H-OADM1x2-947-948-4C	945, 946 ; 947, 948	⇐
	H-OADM1x2-949-950-4C ; H-OADM1x2-951-952-4C	949, 950 ; 951, 952	⇐
	H-OADM1x2-953-954-4C ; H-OADM1x2-955-956-4C	953, 954 ; 955, 956	⇐
	H-OADM1x2-957-958-4C ; H-OADM1x2-959-960-4C	957, 958 ; 959, 960	⇐
Channel spacing	100GHz ITU G.694.1	⇐	
Channel passband -3dB	Min 72.5GHz	⇐	
Passband Ext Rx ⇔ Line Tx, excl add/drop ch	1500 -1600nm / 187.4 to 199.9THz excl. ch passband	⇐	
Insertion loss Ext Rx ⇔ Line Tx (A)	≤ 1.0dB	⇐	
Channel insertion loss: Line Rx ⇔ Ch Tx (B)	≤ 1.1dB	⇐	
Channel link loss, Ch Rx ⇔ Line Tx ⇔ Line Rx ⇔ Ch Tx (C)	≤ 2.0dB	⇐	
Insertion loss, monitor	18-22dB without including the mux, demux or passband loss	⇐	
Isolation, adjacent channel	≥ 28dB	⇐	
Isolation, non-adjacent channel	≥ 40dB	⇐	
Ripple, passband	≤ 0.5dB	⇐	
Directivity	≥ 45dB	⇐	
Return loss	≥ 40dB	⇐	
Max power handling	Up to 500mW	⇐	
Operating temperature	0°C - +70 °C	-40°C - +85 °C	
Connector type	LC/UPC	⇐	
Mounting	H-Series, 55mm width	⇐	



PART NUMBER			
H-OADM1x2-921-922-4C	H-OADM1x2-931-932-4C	H-OADM1x2-941-942-4C	H-OADM1x2-951-952-4C
H-OADM1x2-923-924-4C	H-OADM1x2-933-934-4C	H-OADM1x2-943-944-4C	H-OADM1x2-953-954-4C
H-OADM1x2-925-926-4C	H-OADM1x2-935-936-4C	H-OADM1x2-945-946-4C	H-OADM1x2-955-956-4C
H-OADM1x2-927-928-4C	H-OADM1x2-937-938-4C	H-OADM1x2-947-948-4C	H-OADM1x2-957-958-4C
H-OADM1x2-929-930-4C	H-OADM1x2-939-940-4C	H-OADM1x2-949-950-4C	H-OADM1x2-959-960-4C

9.24 H-OADM2x2-xxx-yyy-4C

PARAMETER	C-TEMP CONDITIONS	I-TEMP CONDITIONS
Channels H-OADM2x2-921-922-4C	192.1 + 192.2 THz	← (same as C-temp)
H-OADM2x2-923-924-4C	192.3 + 192.4 THz	←
H-OADM2x2-925-926-4C	192.5 + 192.6 THz	←
H-OADM2x2-927-928-4C	192.7 + 192.8 THz	←
H-OADM2x2-929-930-4C	192.9 + 193.0 THz	←
H-OADM2x2-931-932-4C	193.1 + 193.2 THz	←
H-OADM2x2-933-934-4C	193.3 + 193.4 THz	←
H-OADM2x2-925-926-4C	193.5 + 193.6 THz	←
H-OADM2x2-937-938-4C	193.7 + 193.8 THz	←
H-OADM2x2-939-940-4C	193.9 + 194.0 THz	←
Channel spacing	100GHz ITU G.694.1	←
Channel passband -3dB	Min 72.5GHz	←
Passband Ext Rx ↔ Line Tx, excl add/drop ch	1460 -1630nm / 183.92 to 205.34THz excl. ch passband	←
Link loss, per channel, Ch Rx↔Line E Tx↔Line W Rx↔Ch Tx (C)	≤ 2.2dB	≤ 2.6dB
Add-drop loss, per channel Ch Rx↔ Line Tx (B)	≤ 1.2dB	≤ 1.4dB
Through loss, Line E Rx↔Line W Tx (A)	≤ 2.2dB	≤ 2.4dB
Insertion loss, monitor	18-22dB without including the mux, demux or passband loss	←
Isolation, adjacent channel	≥ 28dB	←
Isolation, non-adjacent channel	≥ 40dB	←
Ripple, passband	≤ 0.5dB	←
Directivity	≥ 45dB	←
Return loss	≥ 40dB	←
Max power handling	Up to 500mW	←
Operating temperature	0°C - +70°C	-40°C - +85°C
Connector type	LC/UPC	←
Module width	65mm	←

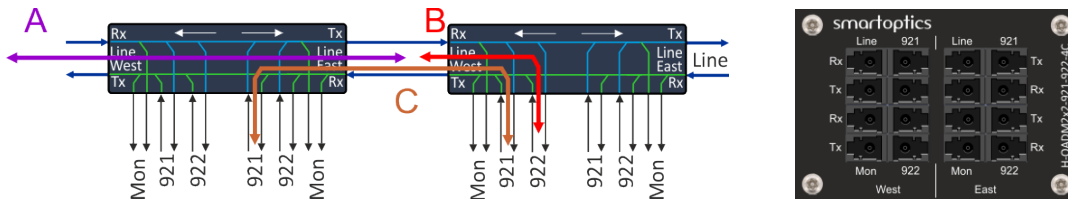

PART NUMBER	DESCRIPTION
H-OADM2x2-921-922-4C	2ch DWDM 400G 2-way OADM + Mon, 921-922
H-OADM2x2-923-924-4C	2ch DWDM 400G 2-way OADM + Mon, 923-924
H-OADM2x2-925-926-4C	2ch DWDM 400G 2-way OADM + Mon, 925-926
H-OADM2x2-927-928-4C	2ch DWDM 400G 2-way OADM + Mon, 927-928
H-OADM2x2-929-930-4C	2ch DWDM 400G 2-way OADM + Mon, 929-930
H-OADM2x2-931-932-4C	2ch DWDM 400G 2-way OADM + Mon, 931-932
H-OADM2x2-933-934-4C	2ch DWDM 400G 2-way OADM + Mon, 933-934
H-OADM2x2-925-926-4C	2ch DWDM 400G 2-way OADM + Mon, 935-936
H-OADM2x2-937-938-4C	2ch DWDM 400G 2-way OADM + Mon, 937-938
H-OADM2x2-939-940-4C	2ch DWDM 400G 2-way OADM + Mon, 939-940

9.25 H-MD-BP1x5

PARAMETER		
Channels	Band 1	192.1 to 192.8THz
	Band 2	192.9 to 193.6THz
	Band 3	193.7 to 194.4THz
	Band 4	194.5 to 195.2THz
	Band 5	195.3 to 196.0THz
Channel spacing	100GHz (ITU)	
Channel passband 1	Center wavelength: 1557.775nm	Passband (-0.5dB): Min 5.89nm
Channel passband 2	Center wavelength: 1551.32nm	Passband (-0.5dB): Min 5.84nm
Channel passband 3	Center wavelength: 1554.93nm	Passband (-0.5dB): Min 5.80nm
Channel passband 4	Center wavelength: 1539.375nm	Passband (-0.5dB): Min 5.75nm
Channel passband 5	Center wavelength: 1532.295nm	Passband (-0.5dB): Min 5.71nm
Insertion loss, per band (A)	Typical 2.2dB Max 2.5dB	
Link loss per band, between two units	Max 4.0dB	
Isolation, Adjacent Channel Passbands	Min 15dB	
Ripple, passband	Max 0.5dB	
Directivity	Min 45dB	
Return loss	Min 40dB	
Polarization dependent loss	Max 0.2dB	
Polarization mode dispersion	Max 0.20ps	
Max optical power	Max 500mW	
Operating temperature	-40°C to +85°C	
Storage temperature	-40°C to +85°C	
Connector type	LC/UPC	
Module width	55mm	

Note! A typical loss value is to be seen as a value that ~90% of a population has at beginning of life and at room temperature. The max value is the guaranteed worst-case value over time and over temperature.

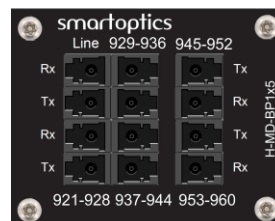
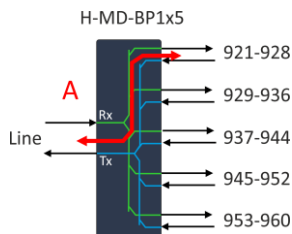

PART NUMBER	DESCRIPTION
H-MD-BP1x5	H-Series: 1x5 Band DWDM Mux/Demux, 921-928, 929-936, 937-944, 945-952, 953-960, LC/UPC

9.26 H-MD-BP1x10

PARAMETER	DWDM CHANNELS	CENTER λ	PASSBAND (-0.5DB)
Channels Band 1	192.1 to 192.4 THz	1559.39nm	Min 2,66nm min
Band 2	192.5 to 192.8 THz	1556.15nm	Min 2,64nm
Band 3	192.9 to 193.2 THz	1552.925nm	Min 2,63nm
Band 4	193.3 to 193.6 THz	1549.715nm	Min 2,63nm
Band 5	193.7 to 194.0 THz	1546.52nm	Min 2,62nm
Band 6	194.1 to 194.4 THz	1543.335nm	Min 2,61nm
Band 7	194.5 to 194.8 THz	1540.165nm	Min 2,59nm
Band 8	194.9 to 195.2 THz	1537.005nm	Min 2,59nm
Band 9	195.3 to 195.6 THz	1533.86nm	Min 2,58nm
Band 10	195.7 to 196.0 THz	1530.725nm	Min 2,57nm
Channel spacing	100GHz		
Insertion loss, per band (A)	Typical 2.9dB Max 3.2dB		
Isolation, Adjacent Channel Passbands	Min 15dB		
Ripple, passband	Max 0.5dB		
Directivity	Min 45dB		
Return loss	Min 40dB		
Polarization dependent loss	Max 0.2dB		
Polarization mode dispersion	Max 0.20ps		
Operating temperature	-40°C to +85°C		
Storage temperature	-40°C to +85°C		
Max optical power	Max 500mW		
Connector type	LC/UPC		
Module width	84mm		

Note! A typical loss value is to be seen as a value that ~90% of a population has at beginning of life and at room temperature. The max value is the guaranteed worst-case value over time and over temperature.

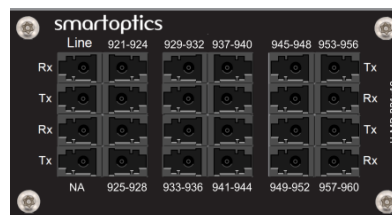
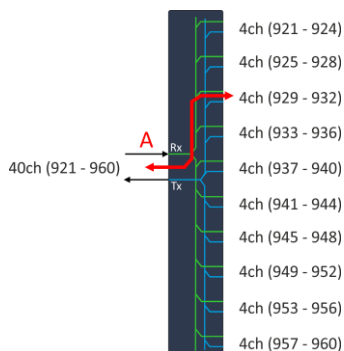

PART NUMBER	DESCRIPTION
H-MD-BP1x10	H-Series: 1x10 Band DWDM Mux/Demux, 921-960, 84mm, Insertion-loss=3.2dB, LC/UPC

9.27 H-CIRC-3P

PARAMETER	C-TEMP CONDITIONS	I-TEMP CONDITIONS
Operating wavelength range λ_1	1530nm to 1570nm (190.95THz – 195.95THz) ¹⁾	⇐
Operating wavelength range λ_2	1490nm to 1530nm (195.95THz – 201.20THz)	⇐
Insertion loss A Rx \Rightarrow COM Tx/Rx (IL1) for wavelength range λ_1	Max 0.9dB	Max 1.1dB
Insertion loss COM Tx/Rx \Rightarrow B Tx (IL2) for wavelength range λ_1	Max 0.9dB	Max 1.1dB
Insertion loss A Rx \Rightarrow COM Tx/Rx (IL1) for wavelength range λ_2	Max 1.3dB	Max 1.4dB
Insertion loss COM Tx/Rx \Rightarrow B Tx (IL2) for wavelength range λ_2	Max 1.3dB	Max 1.4dB
Isolation; COM Tx/Rx \Rightarrow A Rx / B Tx \Rightarrow COM Tx/Rx for λ_1	40dB @ 23°C	⇐
Isolation; COM Tx/Rx \Rightarrow A Rx / B Tx \Rightarrow COM Tx/Rx for λ_2	34dB @ 23°C	⇐
Ripple; A Rx \Rightarrow COM Tx/Rx / COM Tx/Rx \Rightarrow B Tx for λ_1 & λ_2	Max 0.4dB	⇐
Directivity	Min 45dB	⇐
Return loss	Min 40dB	⇐
Polarization dependent loss	Max 0.2dB for range λ_1 Max 0.3dB for range λ_2	⇐
Polarization mode dispersion	Max 0.20ps	⇐
Connector type	LC/UPC	⇐
Module width	35 mm	⇐
Operating temperature	0°C to +70°C	-40°C to +85°C
Storage temperature	-40°C to +85°C	⇐
Max optical power	Max 500mW	⇐

1) Typical 40ch DWDM channel plan is from 192.10THz to 196.00THz

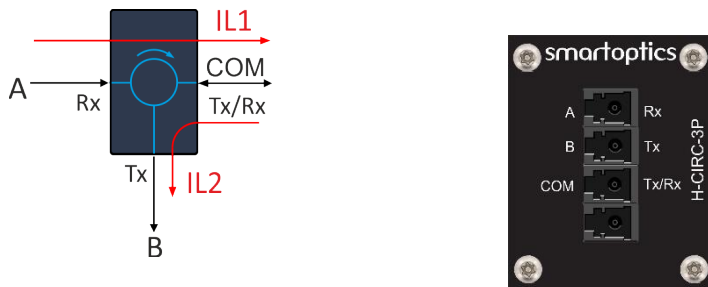

PART NUMBER	DESCRIPTION
H-CIRC-3P	H-Series: Optical circulator 3-port 1550nm, 35mm, LC/UPC

9.28 H-BO-1xMPO-10xLC

PARAMETER	C-TEMP CONDITIONS
Operating band	C-Band DWDM
Insertion loss, MPO	Max 0.7 dB
Insertion loss, LC	Max 0.3 dB
Return loss, MPO	Min 55 dB
Return loss, LC	Min 50 dB
Operating temperature	0°C - +70 °C
Storage temperature	-40°C to +85°C
Connector type	SM LC (UPC), SM MPO-12, Type-B (APC)
Module width	75mm
Mounting	H-Series

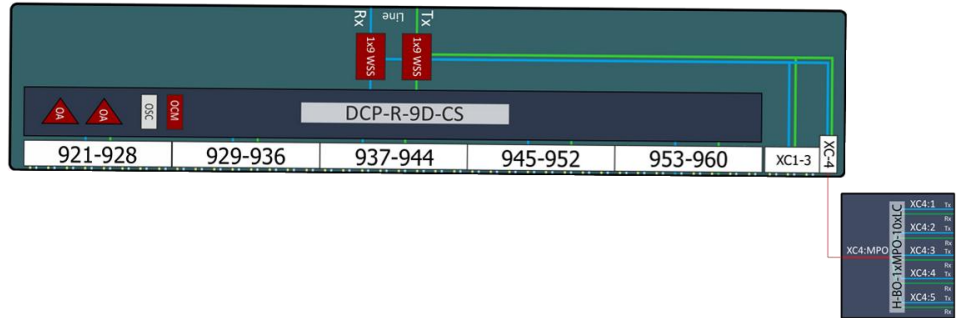
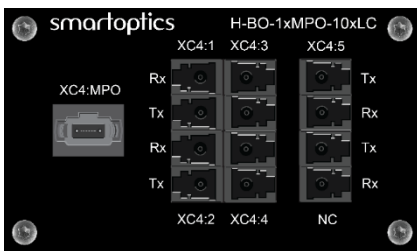

PART NUMBER	DESCRIPTION
H-SB-XC-6MPO	H-Series: 6 degrees shufflebox, 84mm, MPO12 Type-B

9.29 H-SB-XC-6MPO

PARAMETER	C-TEMP CONDITIONS
Operating band	C-Band DWDM
Insertion loss, per fiber	Max 0.7 dB
Return Loss	Min 55dB
Operating temperature	0°C - +70 °C
Storage temperature	-40°C to +85°C
Connector type	MPO-12 (SM, type B, female, APC)
Module width	84mm
Mounting	H-Series

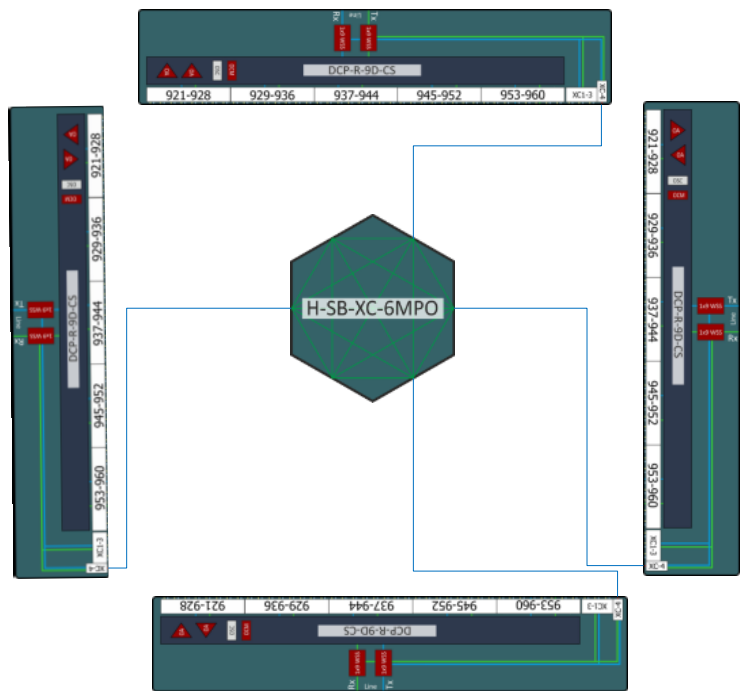
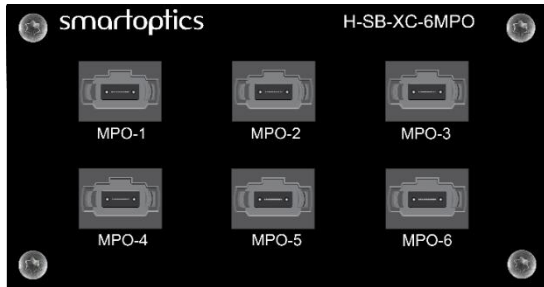

PART NUMBER	DESCRIPTION
H-SB-XC-6MPO	H-Series: 6 degrees shufflebox, 84mm, MPO12 Type-B

9.30 H-BO-SM-1XMPO-8XLC

PARAMETER	CONDITIONS
Operating band	1310, 1550nm
Insertion loss, MPO-12 <-> LC	Max 0.7 dB
Return Loss, MPO-12	Min 50dB
Return Loss, LC	Min 45dB
Operating temperature	-40°C to +85°C
Connector type	MPO-12 (MM, type B, female, UPC) LC (MM, UPC)
Module width	84mm
Mounting	H-Series

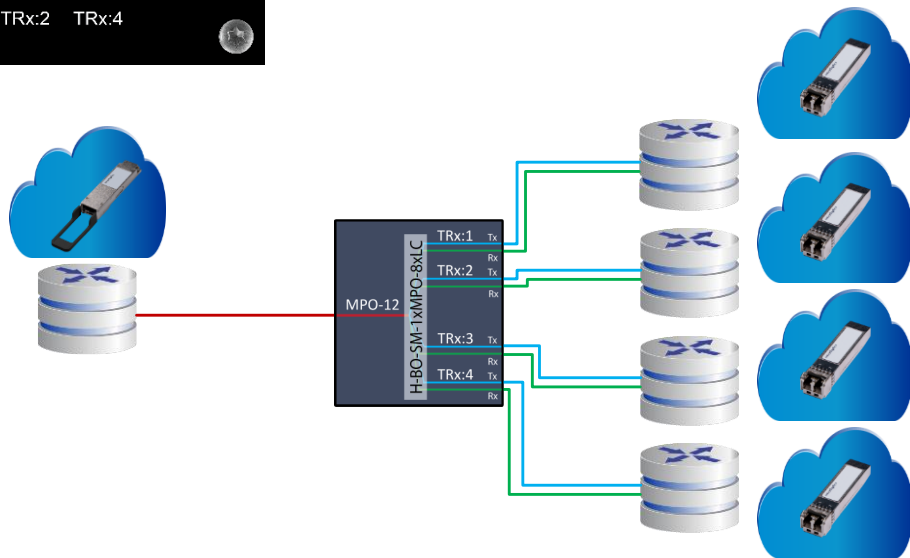
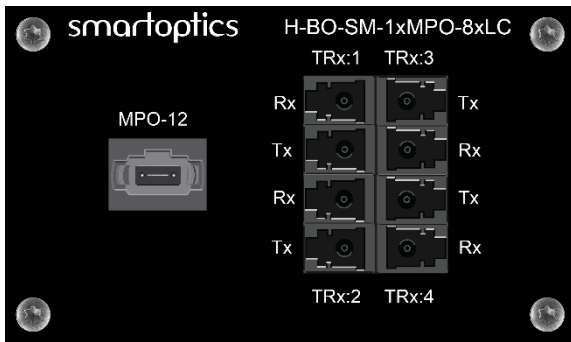

PART NUMBER	DESCRIPTION
H-BO-SM-1xMPO-8xLC	H-Series: Break-out box, 75mm, MPO-12 to 8xLC, Singlemode

9.31 H-BO-MM-1XMPO-8XLC

PARAMETER	CONDITIONS
Operating band	850nm
Insertion loss, MPO-12 <-> LC	Max 0.7 dB
Return Loss, MPO-12	Min 30dB
Return Loss, LC	Min 20dB
Operating temperature	-40°C to +85 °C
Connector type	MPO-12 (MM, type B, female, UPC) LC (MM, UPC)
Module width	84mm
Mounting	H-Series

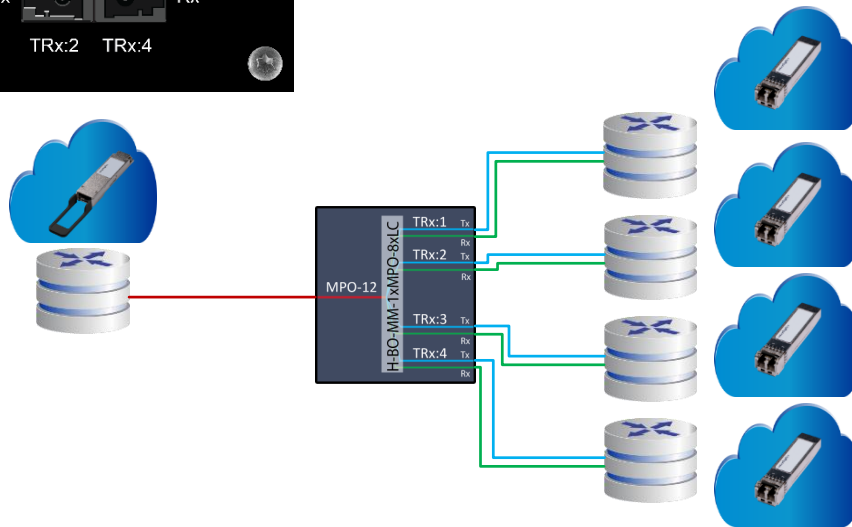
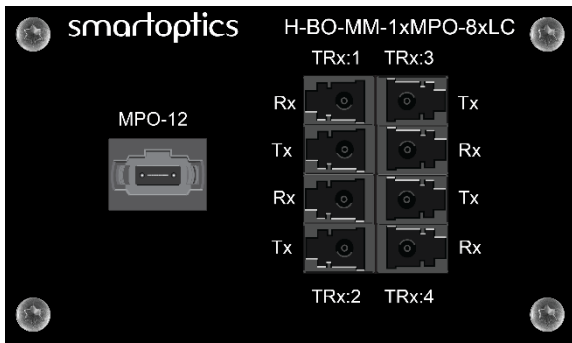

PART NUMBER	DESCRIPTION
H-BO-MM-1xMPO-8xLC	H-Series: Break-out box, 75mm, MPO-12 to 8xLC, Multimode

9.32 H-D1X4

PARAMETER	C-TEMP CONDITIONS	I-TEMP CONDITIONS
Operating wavelength range	1260nm to 1650nm	⇐
Insertion loss Line Tx/Rx ⇔ Tail Tx/Rx	Max 7.5dB	Max 7.5dB
Ripple, passband	Max 0.5dB	⇐
Directivity	Min 50dB	⇐
Return loss	Min 45dB	⇐
Polarization dependent loss	Max 0.2dB	⇐
Polarization mode dispersion	Max 0.20ps	⇐
Max optical power	Max 300mW	⇐
Connector type	LC/UPC	⇐
Module width	55mm	⇐
Operating temperature (I-temp)	0°C to +70°C	-40°C to +85°C
Storage temperature	-40°C to +85°C	⇐

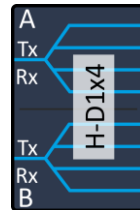
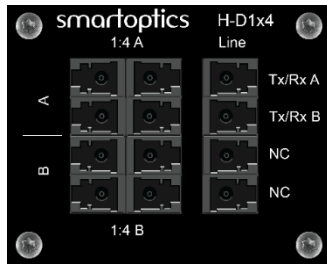

PART NUMBER	DESCRIPTION
H-D1x4	Dual 1:4 Splitter/Combiner

9.33 H-D4X4

PARAMETER		C-TEMP CONDITIONS	I-TEMP CONDITIONS
Operating wavelength range		1260nm to 1630nm	↔
Insertion loss A/B:x Rx ↔ A/B:x Tx (A)	@ 1260~1375 & 1405~1630nm	Max 7.5dB	Max 7.5dB
	@ 1375~1405nm	Max 8.1dB	Max 8.1dB
Ripple, passband		Max 0.5dB	↔
Directivity		Min 50dB	↔
Return loss		Min 45dB	↔
Polarization dependent loss		Max 0.2dB	↔
Polarization mode dispersion		Max 0.20ps	↔
Max optical power		Max 300mW	↔
Connector type		LC/UPC	↔
Module width		65mm	↔
Operating temperature (I-temp)		0°C to +70°C	-40°C to +85°C
Storage temperature		-40°C to +85°C	↔

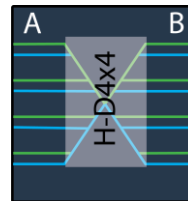
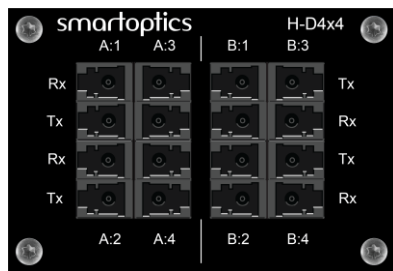

PART NUMBER	DESCRIPTION
H-D4x4	Dual 4:4 Splitter/Combiner

9.34 H-MD-04-921-928-SFx

PARAMETER	C-TEMP CONDITIONS	I-TEMP CONDITIONS
Channels	H-MD-04-929-936-SFA	
Bi-directional channel 1:	Tx: 192.9THz / Rx: 193.0THz	⇐
Bi-directional channel 2:	Tx: 193.1THz / Rx: 193.2THz	⇐
Bi-directional channel 3:	Tx: 193.3THz / Rx: 193.4THz	⇐
Bi-directional channel 4:	Tx: 193.5THz / Rx: 193.6THz	⇐
Channels	H-MD-04-929-936-SFB	
Bi-directional channel 1:	Tx: 193.0THz / Rx: 192.9THz	⇐
Bi-directional channel 2:	Tx: 193.2THz / Rx: 193.1THz	⇐
Bi-directional channel 3:	Tx: 193.4THz / Rx: 193.3THz	⇐
Bi-directional channel 4:	Tx: 193.6THz / Rx: 193.5THz	⇐
Channel spacing	100GHz ITU G.694.1	⇐
Channel passband	ITU±0.11nm	⇐
Passband Ext-port, Ext Tx/Rx↔Line Tx/Rx, excl add/drop ch	1460 -1630nm / 183.92 to 205.34THz excl. ch passband	⇐
Link loss, per channel, Ch Rx↔Line Tx↔Line Rx↔Ch Tx (A)	≤ 4.6	≤ 5.0dB
Link loss, Extension, Ext Rx↔Line Tx↔Line Rx↔Ext Tx (B)	≤ 1.8	≤ 2.0dB
Insertion loss, monitor	18-22dB without including the mux, demux or passband loss	⇐
Isolation, adjacent channel	≥ 28dB	⇐
Isolation, non-adjacent channel	≥ 40dB	⇐
Ripple, passband	≤ 0.5dB	⇐
Directivity	≥ 45dB	⇐
Return loss	≥ 40dB	⇐
Max power handling	≤ 500mW	⇐
Operating temperature	0°C - +70 °C	-40°C - +85 °C
Connector type	LC/UPC	⇐
Mounting	H-Series	⇐

The I-temp column only shows values that differ from C-temp conditions.

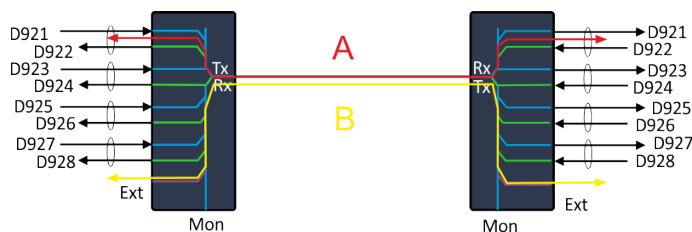

PART NUMBER	DESCRIPTION
H-MD-04-921-928-SFA	4ch DWDM SF Mux/Demux, Extension & Monitor ports 921-928 A
H-MD-04-921-928-SFB	4ch DWDM SF Mux/Demux, Extension & Monitor ports 921-928 B

9.35 H-MD-04-929-936-SFx

PARAMETER	C-TEMP CONDITIONS	I-TEMP CONDITIONS
Channels	H-MD-04-929-936-SFA	
Bi-directional channel 1:	Tx: 192.9THz / Rx: 193.0THz	⇐
Bi-directional channel 2:	Tx: 193.1THz / Rx: 193.2THz	⇐
Bi-directional channel 3:	Tx: 193.3THz / Rx: 193.4THz	⇐
Bi-directional channel 4:	Tx: 193.5THz / Rx: 193.6THz	⇐
Channels	H-MD-04-929-936-SFB	
Bi-directional channel 1:	Tx: 193.0THz / Rx: 192.9THz	⇐
Bi-directional channel 2:	Tx: 193.2THz / Rx: 193.1THz	⇐
Bi-directional channel 3:	Tx: 193.4THz / Rx: 193.3THz	⇐
Bi-directional channel 4:	Tx: 193.6THz / Rx: 193.5THz	⇐
Channel spacing	100GHz ITU G.694.1	⇐
Channel passband	ITU±0.11nm	⇐
Passband Ext-port, Ext Tx/Rx↔Line Tx/Rx, excl add/drop ch	1460 -1630nm / 183.92 to 205.34THz excl. ch passband	⇐
Link loss, per channel, Ch Rx↔Line Tx↔Line Rx↔Ch Tx (A)	≤ 4.6	≤ 5.0dB
Link loss, Extension, Ext Rx↔Line Tx↔Line Rx↔Ext Tx (B)	≤ 1.8	≤ 2.0dB
Insertion loss, monitor	18-22dB without including the mux, demux or passband loss	⇐
Isolation, adjacent channel	≥ 28dB	⇐
Isolation, non-adjacent channel	≥ 40dB	⇐
Ripple, passband	≤ 0.5dB	⇐
Directivity	≥ 45dB	⇐
Return loss	≥ 40dB	⇐
Max power handling	≤ 500mW	⇐
Operating temperature	0°C - +70 °C	-40°C - +85 °C
Connector type	LC/UPC	⇐
Mounting	H-Series	⇐

The I-temp column only shows values that differ from C-temp conditions.

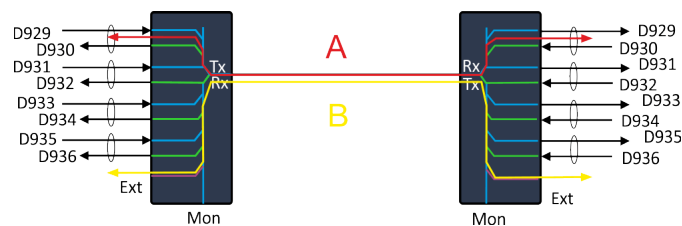

PART NUMBER	DESCRIPTION
H-MD-04-929-936-SFA	4ch DWDM SF Mux/Demux, Extension & Monitor ports 929-936 A
H-MD-04-929-936-SFB	4ch DWDM SF Mux/Demux, Extension & Monitor ports 929-936 B

9.36 H-MD-3155

PARAMETER	C-TEMP CONDITIONS	I-TEMP CONDITIONS
Operating wavelength range 1310 port	1264.5nm to 1350nm	⇐
Operating wavelength range 1550 port	1460nm to 1630nm	⇐
Link loss 1310 ⇔ 1310 (A)	Typ 1.5dB Max 1.7dB	Typ 1.7dB Max 1.9dB
Link loss 1550 ⇔ 1550 (B)	Typ 0.8dB Max 1.0dB	Typ 1.0dB Max 1.2dB
Insertion loss 1310/1550 ⇔ Line (C)	Typ 1.0 dB Max 1.2dB	Typ 1.2dB Max 1.4dB
Isolation, Line Tx ⇐ 1310	Min 30dB	⇐
Isolation, Line Tx ⇐ 1550	Min 12dB	⇐
Ripple, passband	Max 0.5dB	⇐
Directivity	Min 50dB	⇐
Return loss	Min 40dB	⇐
Polarization dependent loss	Max 0.2dB	⇐
Polarization mode dispersion	Max 0.20ps	⇐
Max optical power	Max 300mW	⇐
Connector type	LC/UPC	⇐
Module width	45 mm	⇐
Operating temperature (I-temp)	0°C to +70°C	-40°C to +85°C
Storage temperature	-40°C to +85°C	⇐

Note! A typical loss value is to be seen as a value that ~90% of a population has at beginning of life and at room temperature. The max value is the guaranteed worst-case value over time and over temperature.

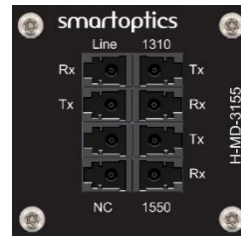
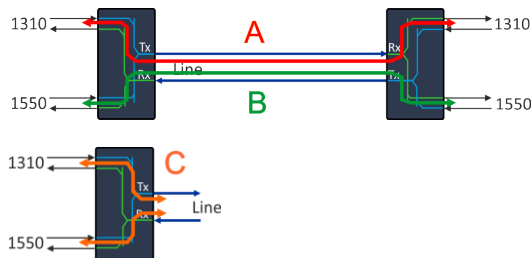

PART NUMBER	DESCRIPTION
H-MD-3155	1310/1550nm band MuxDemux

9.37 H-MD-3155-HI

PARAMETER	C-TEMP CONDITIONS	I-TEMP CONDITIONS
Operating wavelength range 1310 port	1264.5nm to 1350nm	←
Operating wavelength range 1550 port	1460nm to 1630nm	←
Link loss 1310 ↔ 1310 (A)	Typ 2.4dB	Typ 2.8dB
Link loss 1550 ↔ 1550 (B)	Typ 2.4dB	Typ 2.8dB
Insertion loss 1310/1550 ↔ Line (C)	Typ 1.2dB	Typ 1.4dB
Isolation, Line Tx ↔ 1310	Min 30dB	←
Isolation, Line Tx ↔ 1550	Min 50dB	←
Ripple, passband	Max 0.5dB	←
Directivity	Min 50dB	←
Return loss	Min 40dB	←
Polarization dependent loss	Max 0.2dB	←
Polarization mode dispersion	Max 0.20ps	←
Max optical power	Max 300mW	←
Connector type	LC/UPC	←
Module width	45 mm	←
Operating temperature (I-temp)	0°C to +70°C	-40°C to +85°C
Storage temperature	-40°C to +85°C	←

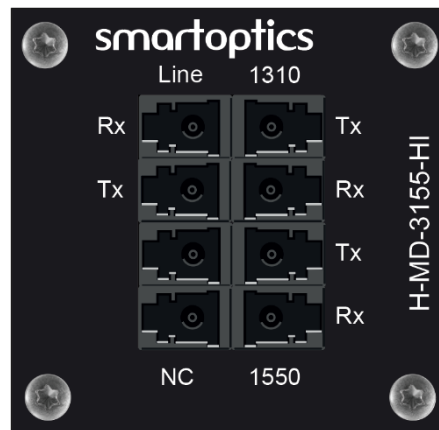
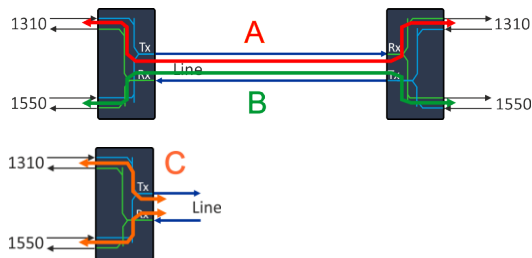

PART NUMBER	DESCRIPTION
H-MD-3155-HI	1310/1550nm band MuxDemux, High Isolation

9.38 H-MD-4LAN-EM-SFx

PARAMETER	C-TEMP CONDITIONS	I-TEMP CONDITIONS
Transmitted channels H-MD-4LAN-EM-SFA	1277.89nm 1286.66nm 1295.56nm 1304.58nm	←
Transmitted channels H-MD-4LAN-EM-SFB	1282.26nm 1291.10nm 1300.05nm 1309.14nm	←
Passband Ext-port	1528.66 to 1561.53nm / 192.0 to 196.10THz	←
Channel spacing	800GHz	←
Insertion loss, per LANWDM channel (A)	Typ 3.0dB Max 3.3dB	Typ 3.0dB Max 3.5dB
Link loss, per LANWDM channel (B)	Typ 4.0dB Max 4.5dB	Typ 4.0dB Max 4.9dB
Insertion loss, Extension port (C)	Typ 0.9dB Max 1.2dB	Typ 1.0dB Max 1.4dB
Link loss, Extension port (D)	Typ 1.8dB Max 2.4dB	Typ 2.0dB Max 2.8dB
Insertion loss, monitor	Min 19dB Max 22dB	←
Isolation, adjacent channel Line Tx/Rx ⇒ channels Rx/Tx	Min 25dB	←
Isolation, non-adjacent channel Line Tx/Rx ⇒ channels Rx/Tx	Min 40dB	←
Isolation, non-adjacent channel Line Tx/Rx ⇒ Ext Rx/Tx	Min 25dB	←
Ripple, passband	Max 0.5dB	←
Directivity	Min 45dB	←
Return loss	Min 40dB	←
Polarization dependent loss	Max 0.2dB	←
Polarization mode dispersion	Max 0.20ps	←
Operating temperature	0°C to +70°C	-40°C to +85°C
Storage temperature	-40°C to +85°C	←
Max optical power	Max 300mW	←
Connector type	LC/UPC	←
Module width	55mm	←

¹⁾ Note! A typical loss value is to be seen as a value that ~90% of a population has at beginning of life and at room temperature. The max value is the guaranteed worst-case value over time and over temperature.

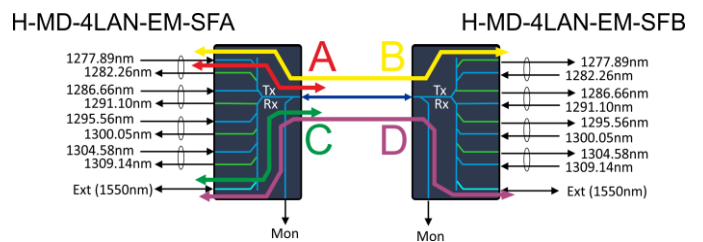
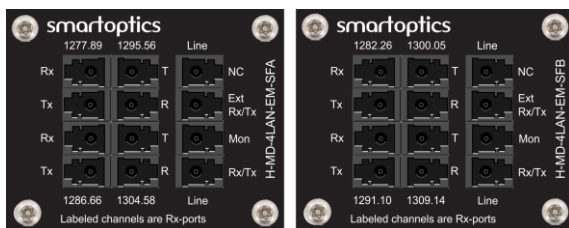

PARAMETER	DESCRIPTION
H-MD-4LAN-EM-SFA	4-channel Single-fiber LANWDM Mux/Demux with Extension and Monitor ports, A-side
H-MD-4LAN-EM-SFB	4-channel Single-fiber LANWDM Mux/Demux with Extension and Monitor ports, B-side

9.39 H-MD-4LAN-295-309

PARAMETER	C-TEMP CONDITIONS	I-TEMP CONDITIONS
Operating Wavelengths	1295.56nm, 1300.05nm, 1304.58nm, 1309.14nm	⇐
Channel spacing	800GHz	⇐
Channel passband -3dB	±1.15nm	⇐
Insertion loss, per LANWDM channel (A)	Max 1.7 dB	Max 1.9dB
Link loss, per LANWDM channel (B)	Max 3.0dB	Max 3.5dB
Insertion loss, monitor	18-22dB without including the mux, demux or passband loss	⇐
Isolation, adjacent channel	Min 25dB	⇐
Isolation, non-adjacent channel	Min 40dB	⇐
Ripple, passband	Max 0.5dB	⇐
Directivity	Min 45dB	⇐
Return loss	Min 40dB	⇐
Polarization dependent loss	Max 0.2dB	⇐
Polarization mode dispersion	Max 0.20ps	⇐
Max power handling	Max 300mW	⇐
Operating temperature	0°C - +70 °C	-40°C - +85 °C
Connector type	LC/UPC	⇐
Module width	55mm	⇐

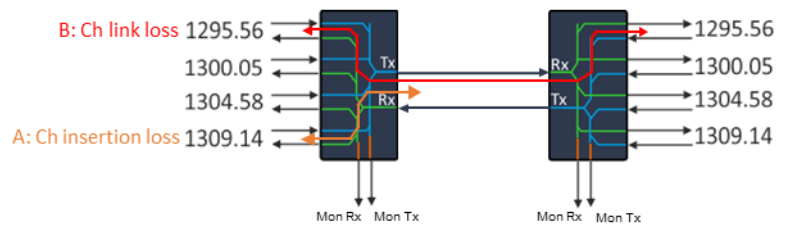
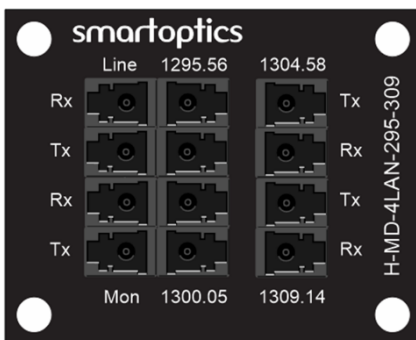

9.40 H-MD-8OWDM-284-289

PARAMETER	C-TEMP CONDITIONS	I-TEMP CONDITIONS
Operating Frequencies [THz]	228.4, 228.6, 228.8, 229.0, 229.2, 229.4, 229.6, 229.8	⇐
Channel spacing	200GHz	⇐
Channel passband	ITU ± 0.2nm	⇐
Insertion loss, per channel (A)	Max 3.0dB	Max 3.5dB
Link loss, per channel (B)	Max 4.6dB	Max 5.2dB
Insertion loss, monitor	18-22dB without including the mux, demux or passband loss	⇐
Isolation, adjacent channel	Min 25dB	⇐
Isolation, non-adjacent channel	Min 45dB	⇐
Ripple, passband	Max 0.5dB	⇐
Directivity	Min 50dB	⇐
Return loss	Min 45dB	⇐
Polarization dependent loss	Max 0.2dB	⇐
Polarization mode dispersion	Max 0.20ps	⇐
Max power handling	Max 500mW	⇐
Operating temperature	0°C - +70 °C	-40°C - +85 °C
Storage temperature	-40°C to +85°C	⇐
Connector type	LC/UPC	⇐
Module width	75mm	⇐

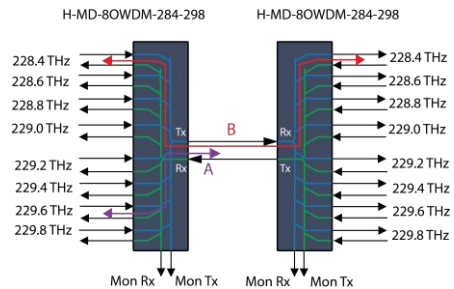
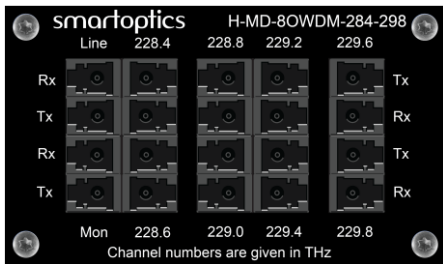

PART NUMBER	DESCRIPTION
H-MD-8OWDM-284-298	H-Series: 8ch OBand WDM Mux/Demux 228.4, 228.6, 228.8, 229.0, 229.2, 229.4, 229.6, 229.8THz, Mon, 75mm, LC/UPC

9.41 H-MD-16OWDM-284-314

PARAMETER	C-TEMP CONDITIONS	I-TEMP CONDITIONS
Operating Frequencies [THz]	228.4, 228.6, 228.8, 229.0, 229.2, 229.4, 229.6, 229.8, 230.0, 230.2, 230.4, 230.6, 230.8, 231.0, 231.2, 231.4	⇐
Channel spacing	200GHz	⇐
Channel passband	ITU ± 0.2nm	⇐
Insertion loss, per channel (A)	Max 3.0dB	Max 3.5dB
Link loss, per channel (B)	Max 4.6dB	Max 5.2dB
Insertion loss, monitor	18-22dB without including the mux, demux or passband loss	⇐
Isolation, adjacent channel	Min 25dB	⇐
Isolation, non-adjacent channel	Min 45dB	⇐
Ripple, passband	Max 0.5dB	⇐
Directivity	Min 50dB	⇐
Return loss	Min 45dB	⇐
Polarization dependent loss	Max 0.2dB	⇐
Polarization mode dispersion	Max 0.20ps	⇐
Max power handling	Max 500mW	⇐
Operating temperature	0°C - +70 °C	-40°C - +85 °C
Storage temperature	-40°C to +85°C	⇐
Connector type	LC/UPC	⇐
Module width	75mm	⇐

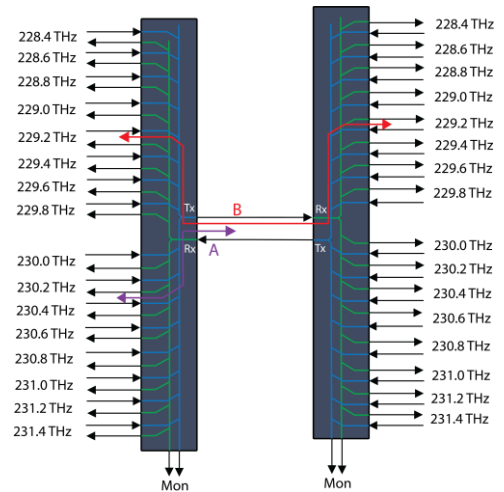
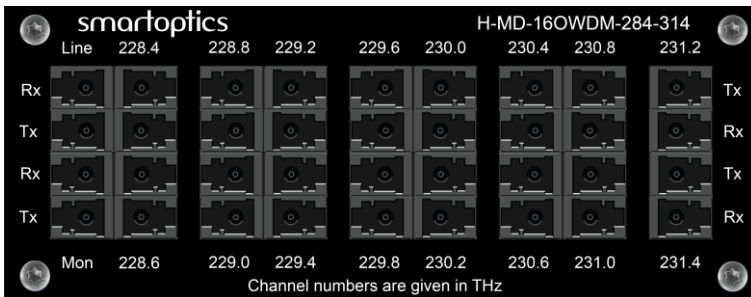

PART NUMBER	DESCRIPTION
H-MD-16OWDM-284-314	H-Series: 16ch OWDM Mux/Demux 228.4-231.4THz, Mon, 113mm, LC/UPC